

Data Sheet

Customer: _____
Part No: **CL-SP192RGB-02** _____
Sample No: _____
Description: _____
Item No: _____

Customer			
Check	Inspection	Approval	Date

1.6X1.5mm SMD CHIP LED

CL-SP1608RGB-02



ATTENTION
OBSERVE PRECAUTIONS
FOR HANDLING
ELECTROSTATIC
SENSITIVE DEVICES

Features

- _1.6mmx0.8mm SMT LED,0.70mm THICKNESS.
- _LOW POWER CONSUMPTION.
- _WIDE VIEWING ANGLE.
- _IDEAL FOR BACKLIGHT AND INDICATOR.
- _VARIOUS COLORS AND LENS TYPES AVAILABLE.
- _PACKAGE : 4000PCS / REEL.
- _RoHS COMPLIANT.

Description

The Blue source color devices are made with GaN on Sapphire Light Emitting Diode.

The Green source color devices are made with InGaN on SiC Light Emitting Diode.

The Hyper Orange source color devices are made with DH InGaAlP on GaAs substrate Light Emitting Diode.

Static electricity and surge damage the LEDs.

It is recommended to use a wrist band or anti-electrostatic glove when handling the LEDs.

All devices, equipment and machinery must be electrically grounded.

Package Dimensions

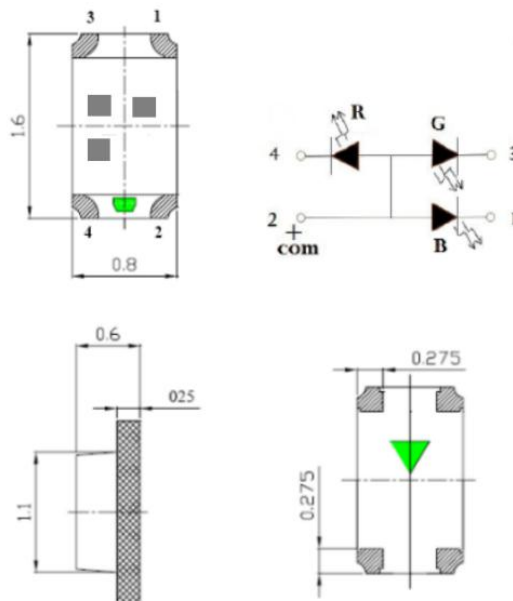

Notes:

1. All dimensions are in millimeters (inches).
2. Tolerance is ± 0.1 (0.004") unless otherwise noted.
3. Specifications are subject to change without notice.

Selection Guide

Part No.	Dice	Lens Type	Iv (mcd) @ 20mA		Viewing Angle
			Min.	MAX.	2 θ 1/2
CL-SP192RGB-02	BLUE (GaN)	WATER CLEAR	100	200	120
	GREEN (InGaN)		380	460	
	RED (InGaAlP)		100	200	

Note:

1. θ 1/2 is the angle from optical centerline where the luminous intensity is 1/2 the optical centerline value.

Electrical / Optical Characteristics at TA=25°C

Symbol	Parameter	Device	Typ.	Max.	Units	Test Conditions
λ_{peak}	Peak Wavelength	Blue Green Red			nm	IF=20mA
λ_D	Dominant Wavelength	Blue Green Red	464 516 617	474 524 625	nm	IF=20mA
$\Delta\lambda_{1/2}$	Spectral Half-width	Blue Green Red	25 38 20		nm	IF=20mA
C	Capacitance	Blue Green Red	100 45 25		pF	VF=0V;f=1MHz
VF	Forward Voltage	Blue Green Red	2.6 2.6 1.9	3.3 3.2 2.3	V	IF=20mA
IR	Reverse Current	Blue Green Red		5 5 5	uA	VR = 5V

Absolute Maximum Ratings at TA=25°C

Parameter	Blue	Green	Red	Units
Power dissipation	135	135	75	mW
DC Forward Current	30	30	30	mA
Peak Forward Current [1]	140	140	140	mA
Reverse Voltage	5	5	5	V
Operating/Storage Temperature	-40°C To +85°C			

Note:

1. 1/10 Duty Cycle, 0.1ms Pulse Width.

Blue

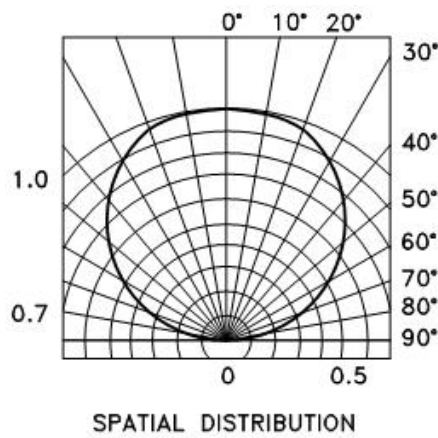
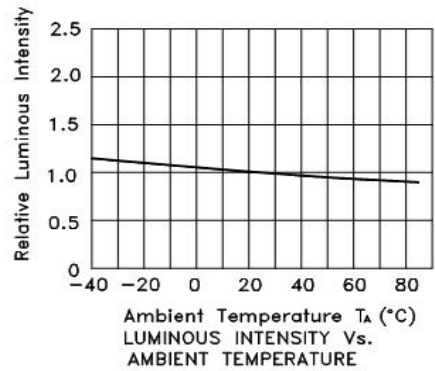
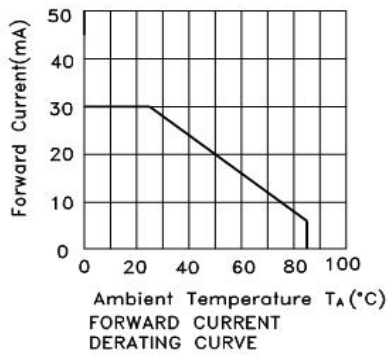
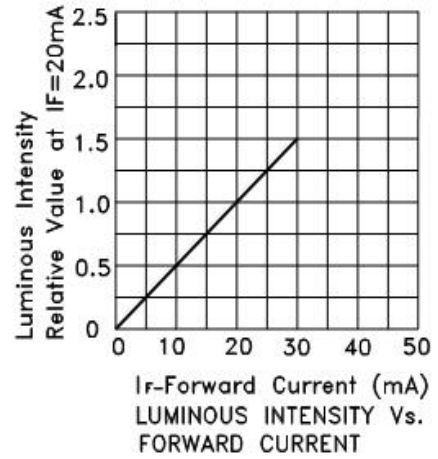
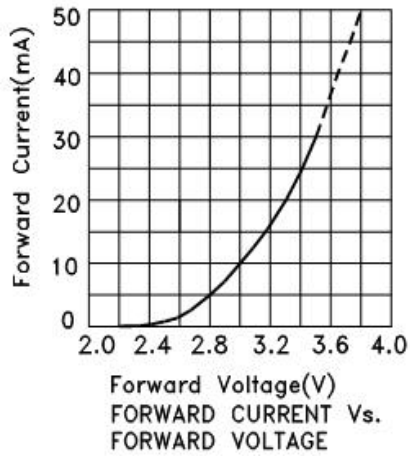
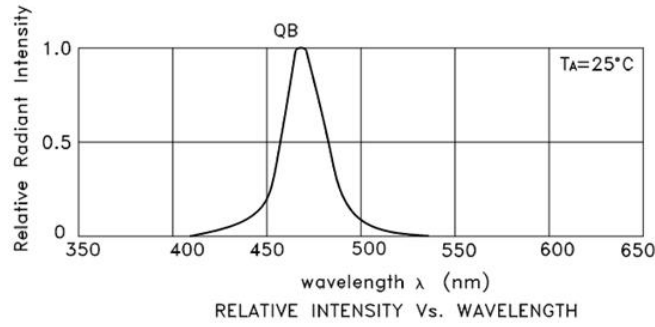

Green

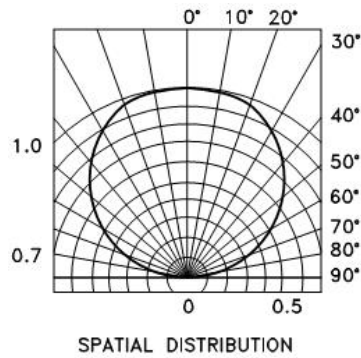
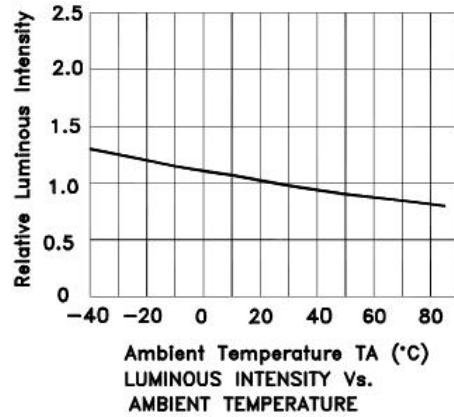
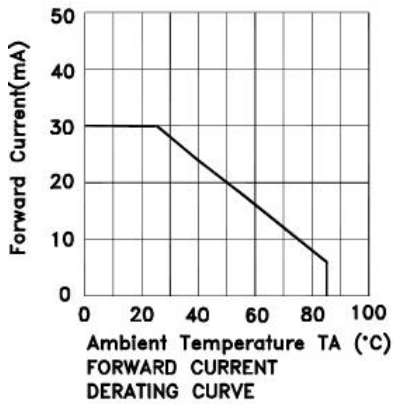
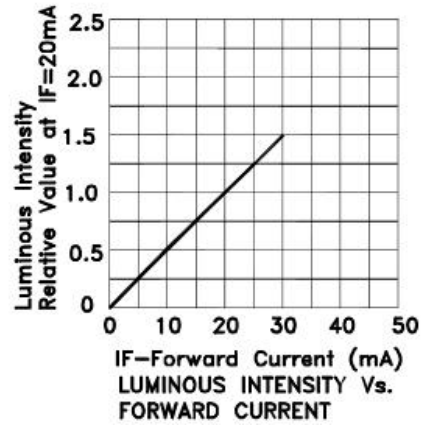
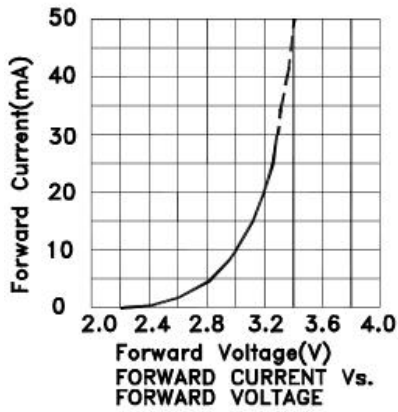
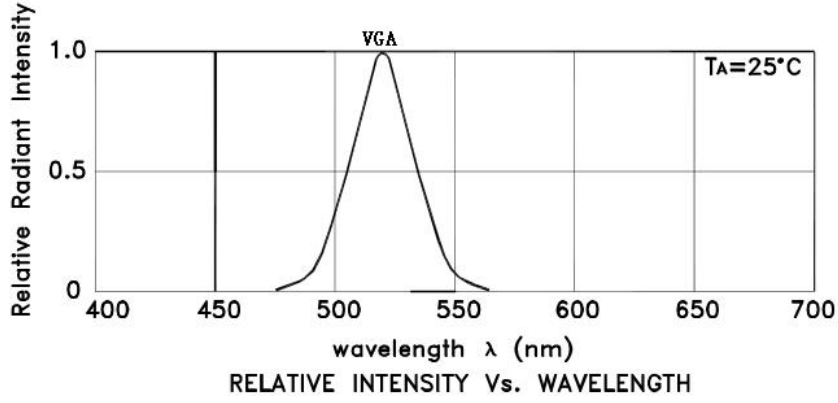

Red

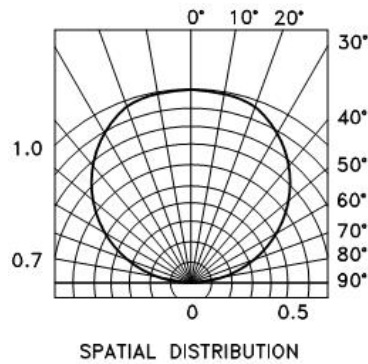
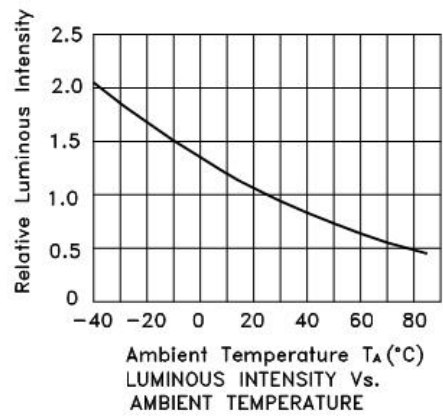
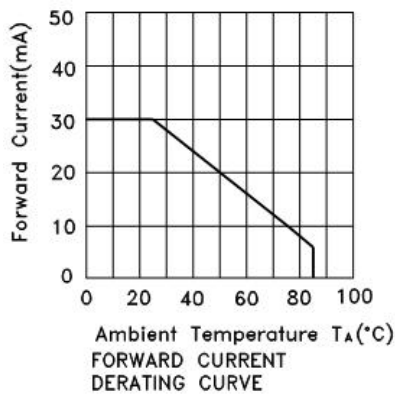
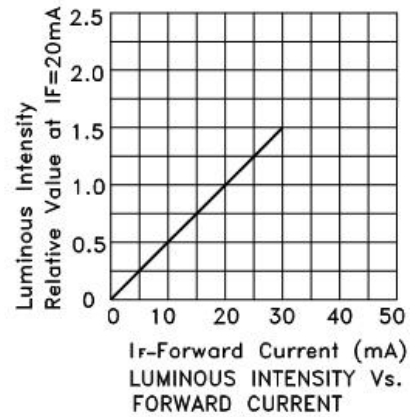
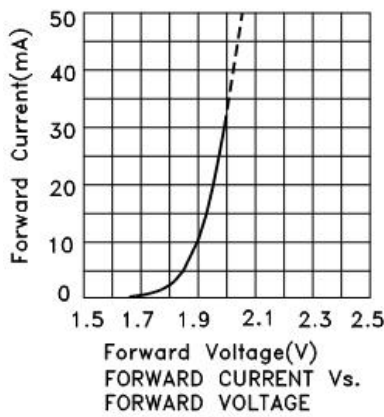
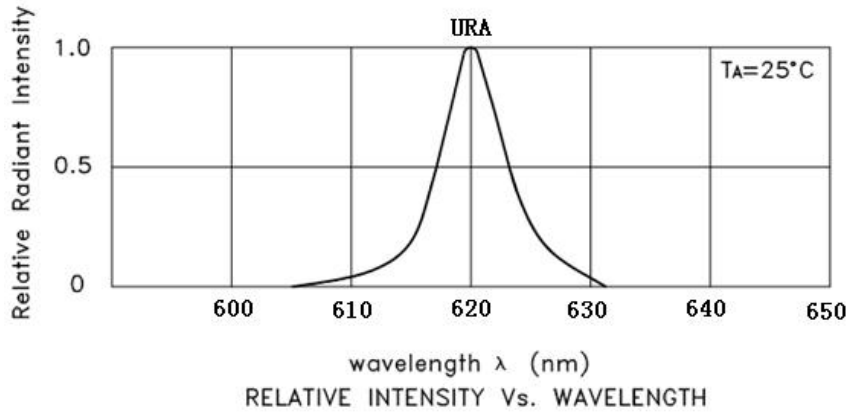

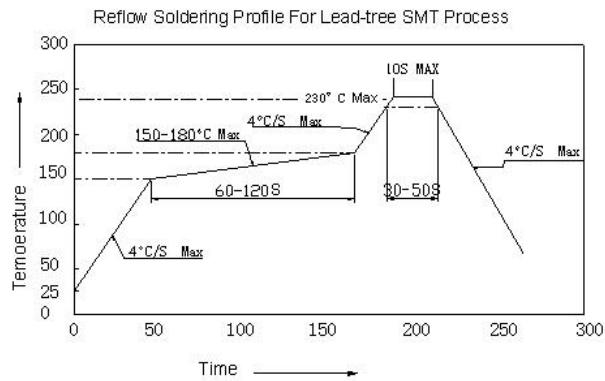
NOTES:

1. We recommend the reflow temperature 245° c(±5) The maximum soldering temperature should be limited to 280° c
2. Don't cause stress too the epoxy resin while it is exposed to high temperature.
3. Number of reflow process shall be 2 time or less.

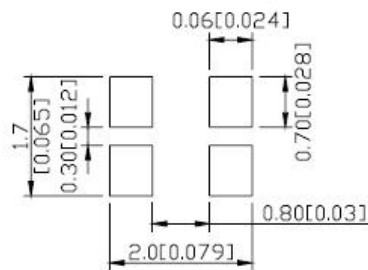
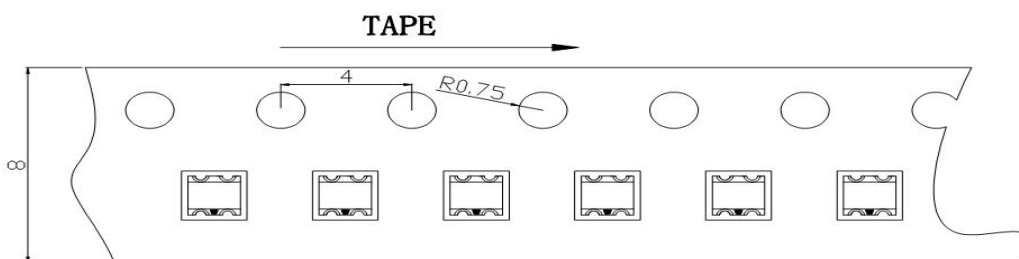
Recommended Soldering Pattern
(Units : mm)

Tape Specifications
(Units : mm)

Package: 4000 pcs/reel
Remarks:

If special sorting is required (e.g. binning based on forward voltage, luminous intensity / luminous flux or wavelength), the typical accuracy of the sorting process is as follows:

1. Wavelength: +/-1nm
2. Luminous Intensity / Luminous Flux: +/-15%
3. Forward Voltage: +/-0.1V

Note: Accuracy may depend on the sorting parameters.