



Date Sheet

Customer:

Part No: CL-SFC281UHR-660-B-02(0.5W)

Sample No: _____

Description: _____

Item No: _____

Customer			
Check	Inspection	Approval	Date



◆ Features :

- Package Size: 2.8(L) × 3.5(W) × 0.8(T)mm
- Silicone Packed
- Suitable for different working environment
- Super long lifetime: 50000HRs
- Anti UV
- White colors are available in(2300K- 25000K)
- Wide viewing angle ($2\theta \ 1/2 = 120^\circ$)

◆ Applications :

- | | |
|---|--|
| <ul style="list-style-type: none"> ■ Mobile phone flash ■ Automotive interior lighting ■ Automotive forward lighting ■ Architectural lighting ■ LCD TV / Monitor backlight | <ul style="list-style-type: none"> ■ Traffic signals ■ Task lighting ■ Decorative/ Pathway lighting
 ■ Remote/Solarpowered lighting
 ■ Household appliances |
|---|--|

Device Selection Guide

ITEM	MATERIALS
Resin	Silicon
Bonding wire	25 Em Au
Lens color	Water Clear
Dice	AlGaInP

REFLECTOR COATING TYPE HIGH-PERFORMANCE LEDs

High Performance SMD Single-Color Top LEDs

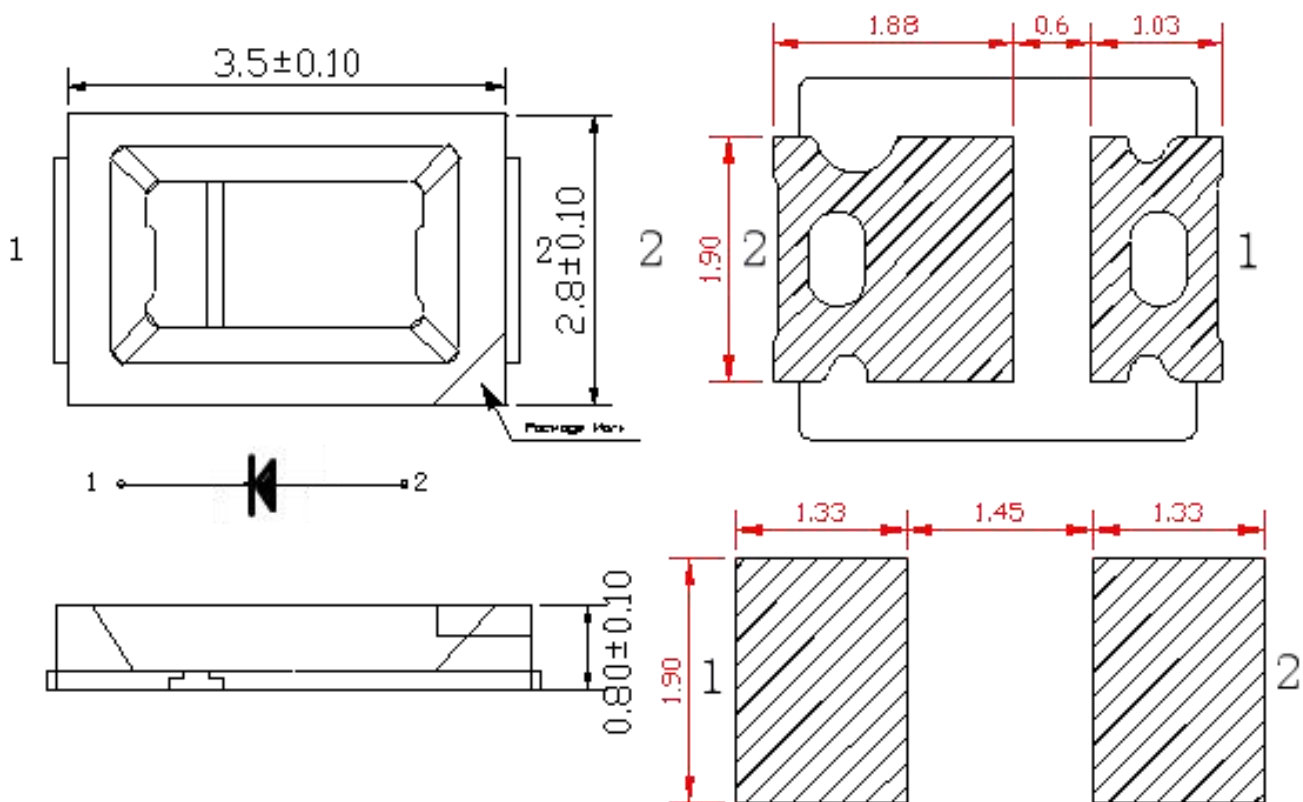

NOTES:

- 1、 All dimensions are in millimeters (inches);
- 2、 Tolerances are 0.2mm (0.008inch) unless otherwise noted

Absolute maximum ratings
(TA=25°C)

Paramete	Symbol	Rat	Unit
Forward current	I F	150	mA
Reverse voltage	VR	5	V
Power dissipation	Pd	0.5	W
Operating Temperature	TOP	-20 ~+80	°C
Storage Temperature	Tstg	-40 ~+80	°C
Peak Forward Current (Duty 1/10 @ 1KHz)	IFP	150	mA
Lead Soldering Temperature (5mm From Body)	TSOI	260°C For 5 Seconds)/°C	

Electro-optical characteristics
(T A =25°C)

Parameter	Test Condition	Symbo	Value			Unit
			Min	Avg	Max	
CIE Coordinates	I F =1500mA	X				
		Y				
Forward voltage	I F =150mA	Vf	1.8	2.0	2.2	V
Wavelength	I F =150mA	nm	660		665	nm
Luminous Flux	I F =150mA	φ	10		15	Lm
Luminous intensity	I F =150mA	Iv				mcd
Viewing Angle	////////	201/2	////////	120	////////	deg
Reverse Current	////////	IR	////////	////	10	EA

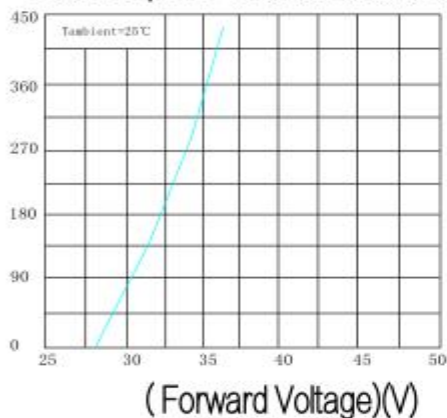
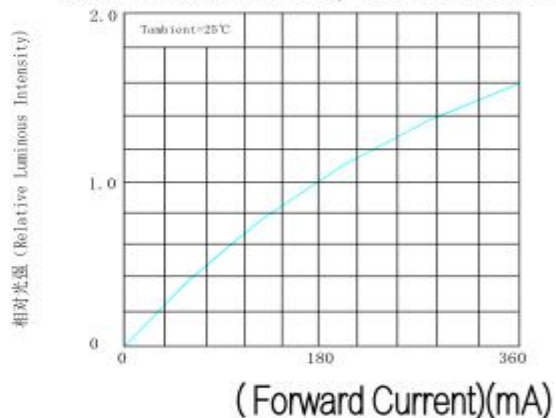
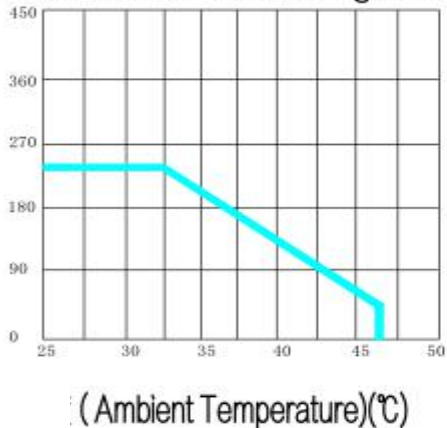
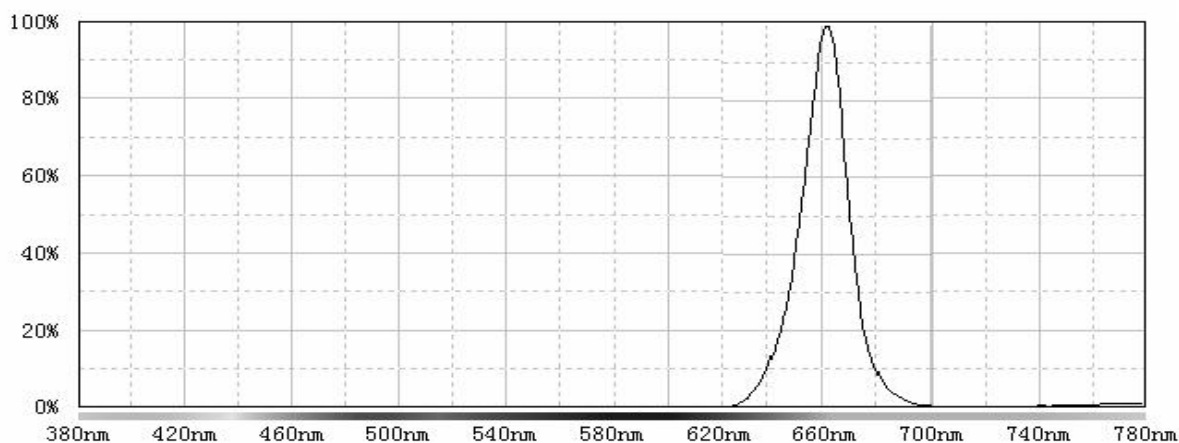
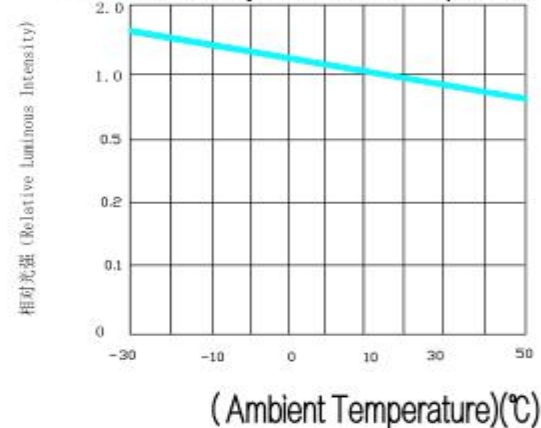
(Optical-Electrical Characteristic)
Volt-Ampere Characteristics

Relative Luminous Intensity VS Forward Current

Forward Current Derating Curve

Luminous Intensity VS Ambient Temperature

Reliability Test Items And Conditions

TestItems	Reference	Test Conditions	Time	Quantity	Criterion
Thermal Shock	MIL-STD-202G	-40℃ (30min) -100℃ (30min)	100Cycles	22	0/22
Temperature	JEITA ED-4701 200 203	-10℃~65℃; 0%~90%RH	10cycles	22	0/22
High temperature storage	JEITA ED -4071 200 201	Ta=100℃	1000H	22	0/22
Low temperature storage	JEITA ED -4071 200 202	Ta=-40℃	1000H	22	0/22
High temperature high humidity storage	JEITA ED -4071 100 103	Ta=60℃; RH=90%	1000H	22	0/22
High temperature life	JESD22-A108D	Ta=80℃	1000H	22	0/22
Normal temperature life test	JESD22-A108D	Ta=25℃ IF=150mA	1000H	22	0/22
Resistance to soldering heat	GB/T 4937, II, 2.2&2.3	Tsol*=(240±5)℃ 10secs	2 times	22	0/22

Criteria For Judging Damage

TestItems	Symbol	Test Conditions	Criteria For Judging Damage
ForwardVoltage	V F	I F =I FT	Initial Data±10%
ReverseCurrent	I R	V R =5V	I R ≤10uA
LuminousIntensity	I V	I F =I FT	Average I V attenuation ≤ 30%; single I V attenuation ≤ 50%
Resistance to soldering heat			No cracks inside the material, no material bursting, peeling, no death light

*Note Tsol-Temperature of tin liquid

(Useful hint) :

1、 Hand Soldering

A soldering iron of less than 20W is recommended to be used in Hand Soldering. Please keep the temperature of the soldering iron under 360°C while soldering. Each terminal of the LED is to go for less than 3 second and for one time only.

Be careful because the damage of the product is often started at the time of the hand soldering.

2. Reflow Soldering: Use the conditions shown in the under Figure of Pb-Free Reflow Soldering

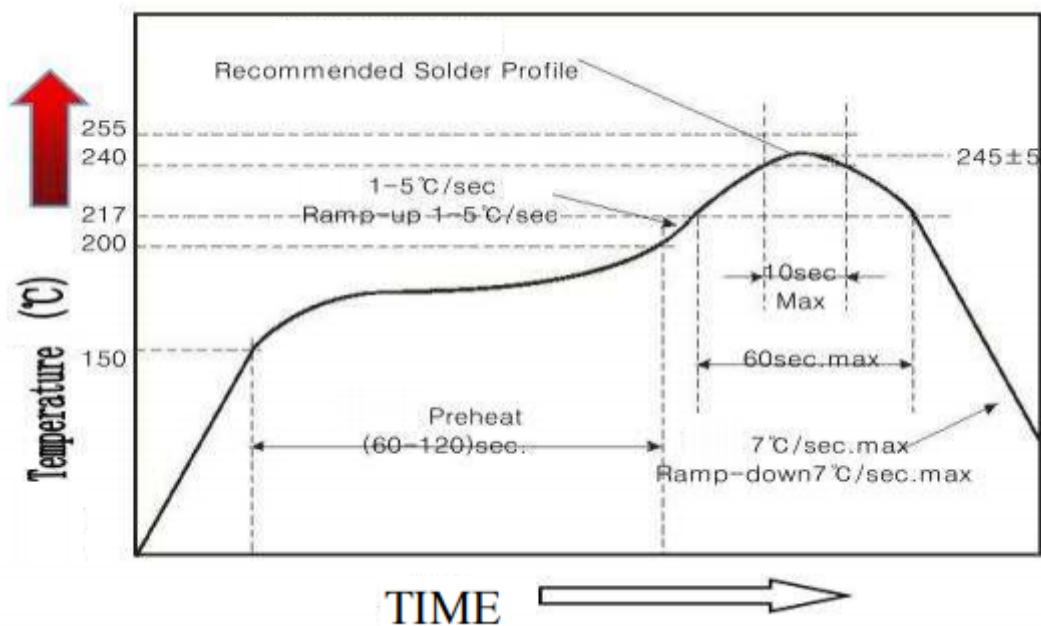

- Reflow soldering only allowed to do once
- Stress on the LEDs should be avoided during heating in soldering process
- After soldering, do not deal with the product before its temperature drop down to room Temperature.

Precautions(1)

1. Storage

- **Moisture proof and anti-electrostatic package with moisture absorbent material is used, to keep moisture to a minimum.**
- **Before opening the package, the product should be kept at 30°C or less and humidity less than 60% RH, and be used within a year.**
- **After opening the package, the product should be stored at 30°C or less and humidity less than 10%RH, and be soldered within 24 hours (1day). It is recommended that the product be operated at the workshop condition of 30°C or less and humidity less than 60%RH.**

- **If the moisture absorbent material has faded away or the LEDs have exceeded the storage time, baking treatment should be performed based on the following condition: (70±5)°C for 24 hours**

2. Static Electricity

Static electricity or surge voltage damages the LEDs. Damaged LEDs will show some unusual characteristics such as the forward voltage becoming lower, or the LEDs do not light at the low current, even not light.

All devices, equipment and machinery must be properly grounded. At the same time, it is recommended that wrist bands or anti-electrostatic gloves, anti-electrostatic containers be used when dealing with the LEDs.

Precautions (2)

3. Vulcanization

LED curing is due to sulfur being in bracket and the +1 price of silver in the chemical reaction generated Ag₂S in the process .It will lead to the capacity of reflecting of silver layer reducing ,light color temperature drift and serious decline ,seriously affecting the performance of the product. So we should take corresponding measures to avioding vulcanization , such as to avoid using sulphur volatile substances and keeping away from high sulphur content of the material.

Handling Precautions

- 1、 Handle the component along the side surface by using forceps or appropriate tools; do not directly touch or Handle the silicone lens surface, it may damage the internal circuitry.

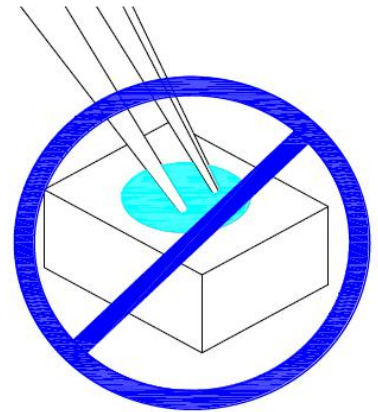
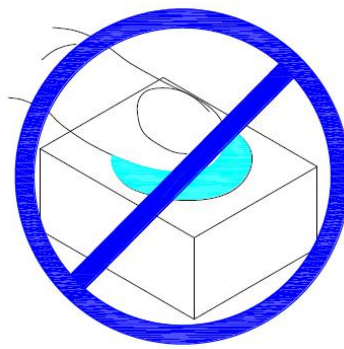
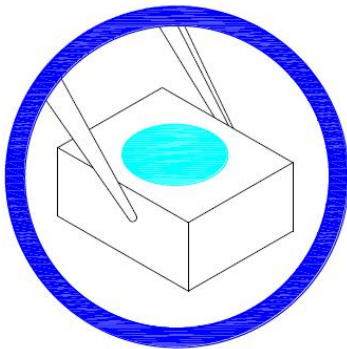

- 2、 Do not stack together assembled PCBs containing LEDs.
PH<7
Impact may scratch the silicone lens or damage the internal circuitry
- 3、 Not suitable to operate in acidic envi-ronment,

