



Data Sheet

Customer:

Part No: CL-SF685RIR-660,880-02

Sample No: _____

Description: _____

Item No: _____

Customer			
Check	Inspection	Approval	Date

Features:

- . Reflow Solderable
- . High Luminous Intensity and Low Power Dissipation
- . Good Reliability and Long Life
- . Complied With RoHS Directive

Technical Data Sheet

This product is generally used as indicator and luminary for electronic equipment such as household appliance, communication equipment, and dashboard.

Applications

- Optical indicator
- Indoor display
- Backlighting in dashboard and switch
- Flat backlighting for LCD, symbol and display
- General use

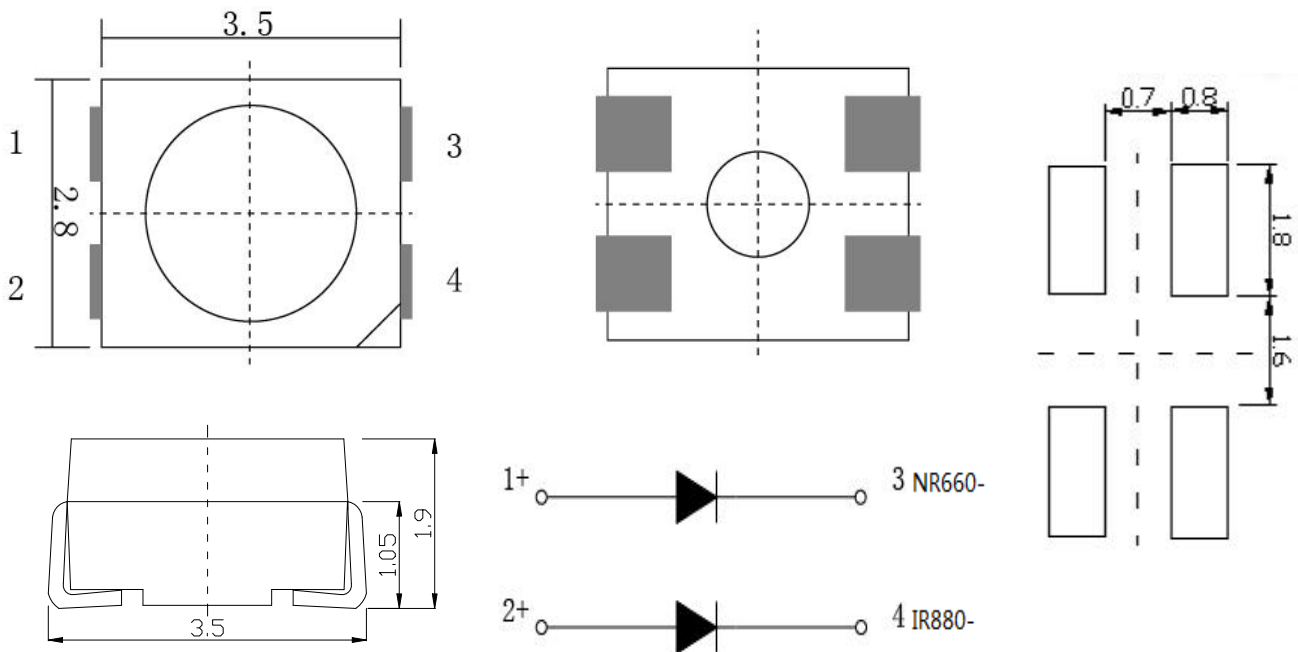

Notes:

1. All dimension units are millimeters.
2. All dimension tolerance is $\pm 0.2\text{mm}$ unless otherwise noted.

Selection Guide

Part No.	Dice	Lens Type	Luminous intensity(mcd) @ 20mA			Viewing Angle
			Min	Typ	Max	201/2
CL-SF685RIR-660,880-02	Water Clear	(R)AlGaInP	210	--	460	120
		Emission intensity (mW/sr)				
		(IR)AlGaInP	--	2.50	--	

1.201/2 is the angle from optical centerline where the luminous intensity is .201/2 the optical centerline value.

2.The above luminous intensity measurement allowance tolerance $\pm 10\%$

Electrical / Optical Characteristics at Ta=25°C

Parameter	Symbol	Min.	Typ.	Max.	Units	test conditions
Forward Voltage	R	1.8		2.6	V	IF=20mA
	IR	1.3	--	1.7		
Reverse Current	IR	--	--	10	uA	VR = 5V
Dominate Wavelength	R	650	--	660	nm	IF=20mA
	IR	--	880	--		

Absolute Maximum Ratings at Ta=25°C

Parameter	Symbol	Rating	Units
Power Dissipation	R	50	mW
	IR	34	
DC Forward Current	IF	20	mA
Peak Forward Current [1]	IFP	75	mA
Reverse Voltage	VR	5	V
Electrostatic Discharge (HBM)	ESD	2000	V
Operating Temperature	Topr	-40~+85	°C
Storage Temperature	Tstg	-40~+100	°C

Note:

- 1/10 Dut cycle,0.1ms pulse width.
2. The above forward voltage measure ment allowance tolerance $\pm 0.1V$.
3. The tolerance of wave length: $\pm 1nm$.

Typical optical characteristics curves

Ambient Temperature VS. Forward Current

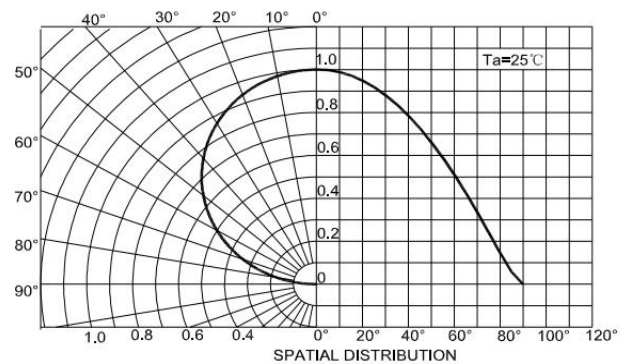
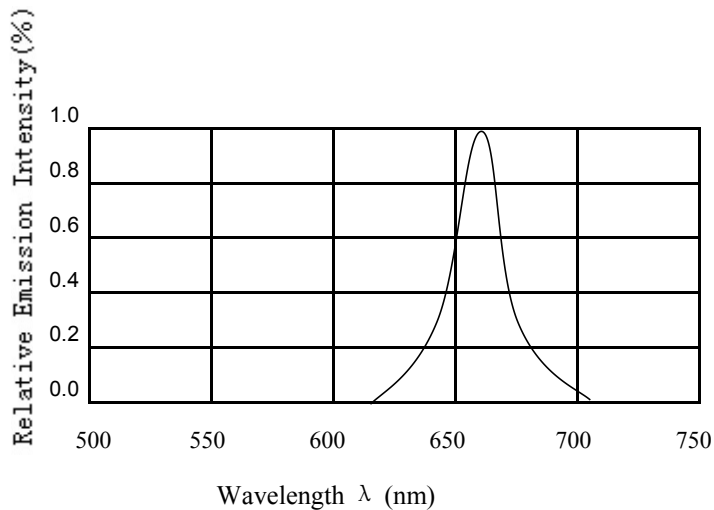
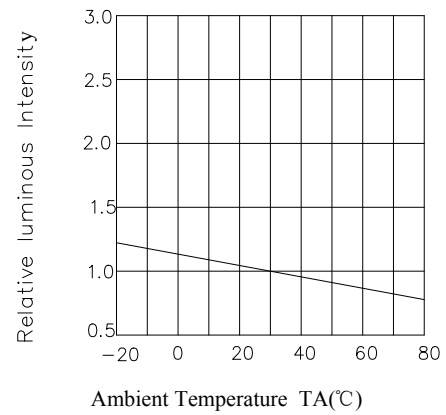
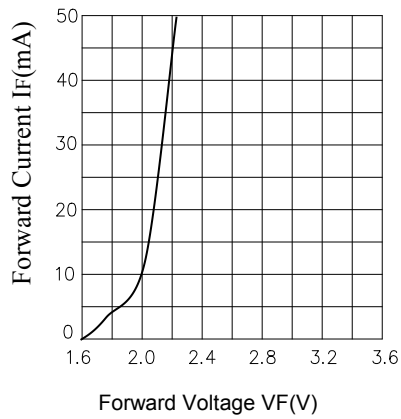
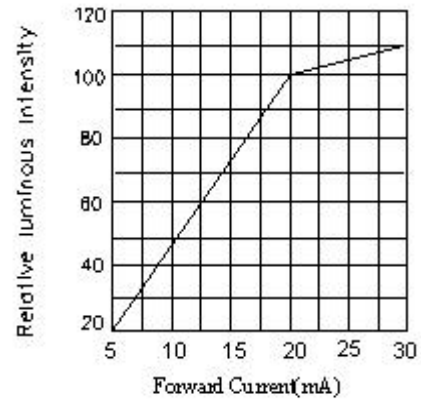
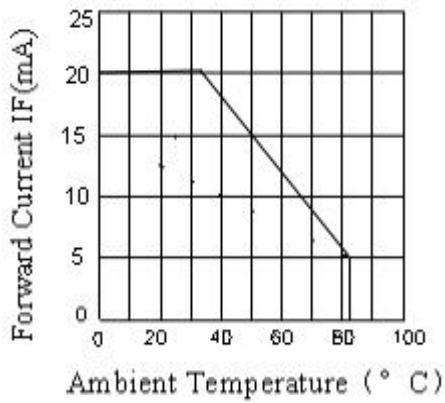

Typical Optical-Electrical Characteristic Curves

Fig.1 Forward Current Vs Forward Voltage

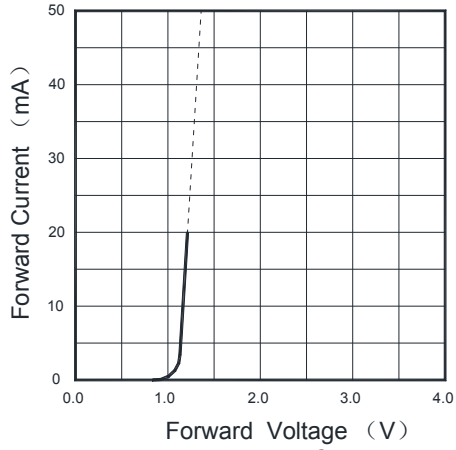

Fig.2 Relative Radiant Intensity Vs Forward Current

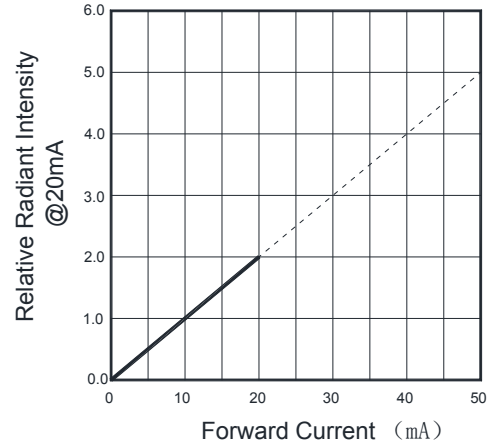

Fig.3 Relative Forward Voltage Vs Ambient Temperature

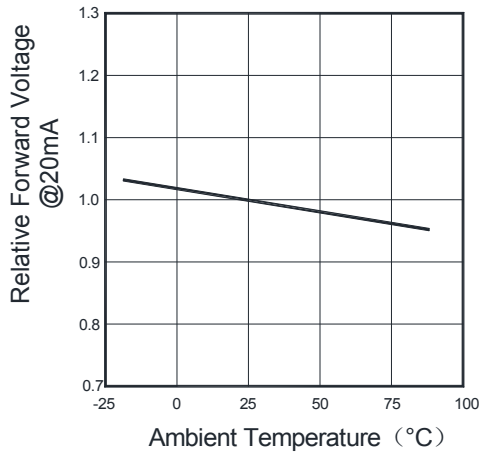

Fig.4 Relative Radiant Intensity Vs Ambient Temperature

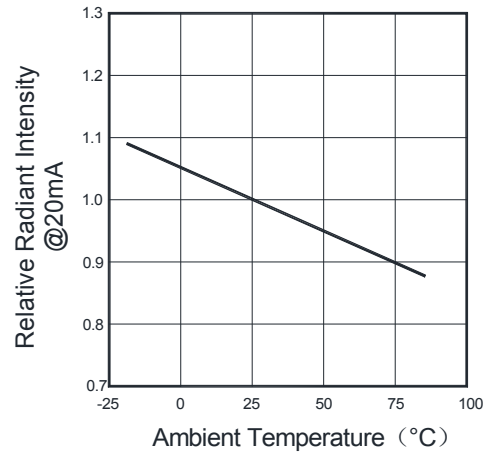

Fig.5 Spectral Distribution

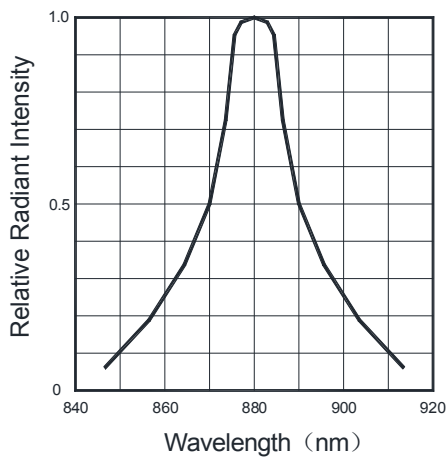
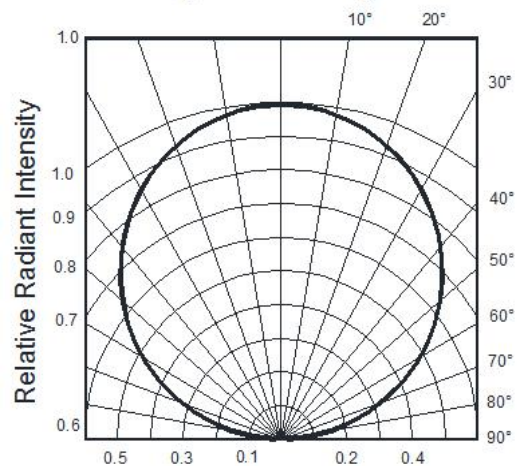

Fig.6 Radiant Diagram



Reliability Test Items And Conditions

Test Items	Ref.Standard	Test conditions	Time	Quantity	Ac/Re
Reflow	JESD22-B106	Temp:260°C max T=10 sec	3 times.	22Pcs.	0/1
Temperature Cycle	JESD22-A104	100°C±5°C 30 min. ↑↓5 min -40°C±5°C 30 min.	100 Cycles	22Pcs.	0/1
High Temperature Storage	JESD22-A103	Temp:100°C±5°C	1000Hrs	22Pcs.	0/1
Low Temperature Storage	JESD22-A119	Temp:-40°C±5°C	1000Hrs	22Pcs.	0/1
Life Test	JESD22-A108	Ta=25°C±5°C IF=20mA	1000Hrs	22Pcs.	0/1
High Temperature High Humidity Life Test	JESD22-A101	85°C±5°C/ 85%RH IF=20mA	1000Hrs	22Pcs.	0/1

Criteria For Judging Damage

Test Items	Symbol	Test conditions	Criteria For Judgement	
			Min.	Max.
Forward Voltage	VF	IF=20mA		U.S.L*)x1.1
Reverse Current	IR	VR = 5V		U.S.L*)x2.0
Luminous intensity	med	IF=20mA	L.S.L*)x0.7	

U.S.L: Upper standard level

L.S.L: Lower standard level

The technical information shown in the data sheets are limited to the typical characteristics and circuit examples of the referenced products.It does not constitute the warranting of industrial property nor the granting of any license.

SMT Reflow Soldering Instructions SMT

1. For secondary high temperature welding, please complete within 24 hours.
2. When soldering, do not put stress on the LEDs during heating.

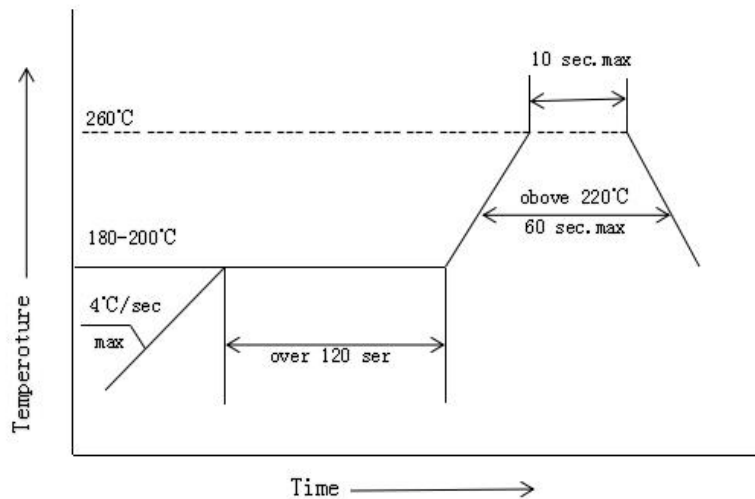

Soldering iron

1. When hand soldering, the temperature of the iron must be less than 315°C for 3 seconds.
2. The hand solder should be done only one time.

Repairing

Repair should not be done after the LEDs have been soldered. When repairing is unavoidable, a double-head soldering iron should be used (as characteristics of LEDs will or will not be damaged by repairing, below figure). It should be confirmed beforehand whether the

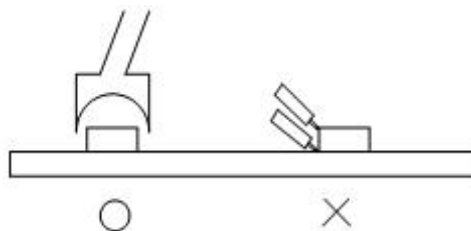

Storage

This product uses sealing anti-moisture antistatic packaging, and with desiccant, humidity card.

Before packaging is opened:

1、 The storage environment is: the ambient temperature should be maintained between 5 °C and 30 °C, and the relative humidity should be maintained within 60 % RH. When the storage time of the product exceeds 2 months, the product must be rebaked for use.

2、 Please check that the package is leaking before opening. If it has leaked, please re-bake and use it or return to the plant to dehumidify.

After opening the package:

1、 After opening the package, check whether the humidity card has a discoloration phenomenon. For example, 20 % of the humidity card indicates discoloration. Please remove the material from the bag and use it after dehumidifying 24H at 65 °C. (To reduce the risk of use, it is recommended that this product be dehumidified at 65 °C / 24H before use)

2、 Environmental conditions: The ambient temperature should be kept between ≤ 30 ° C and relative humidity

The lower 60 % RH should be maintained.

3、 if the material is not produced after exposure in the workshop for more than 24 hours, the product must be put back in the oven, dehumidified with 65 °C 24H, and then can be used again. If the material is not produced after 48 hours of exposure in the workshop, return the material to the SMD plant for high temperature dehumidification.

4、 When the material is dehumidified, please do not open the oven in the middle, so that the oven temperature will not drop to the dehumidification effect.

Please refer to the following operating methods when the material needs to be dehumidified



Correct way: material desiccant need to remove the bag, use the way of hanging baked



Wrong way: the material is dehumidified without removing the bag, in a stacking manner

ESD

Static Electricity will damage the LED.

The following steps can reduce the likelihood of ESD causing product damage

- 1.All productive machinery and test instruments must be electrically grounded.
- 2.Use a conductive wrist band or anti-electostatic glove when handling these LEDs.
- 3.Manintain a humidity level of 50%RH or higher in production areas.
- 4.Use anti-static packaging for transport and storage.

Handling Precautions

- 1.Do not stack the assembled PCB together. This may scratch the surface of the product or damage the circuit.

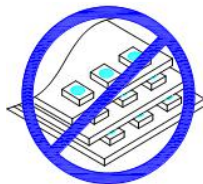

- 2.Not available in the situation of acidity for PH.



- 3.Electrostatic sensitive device

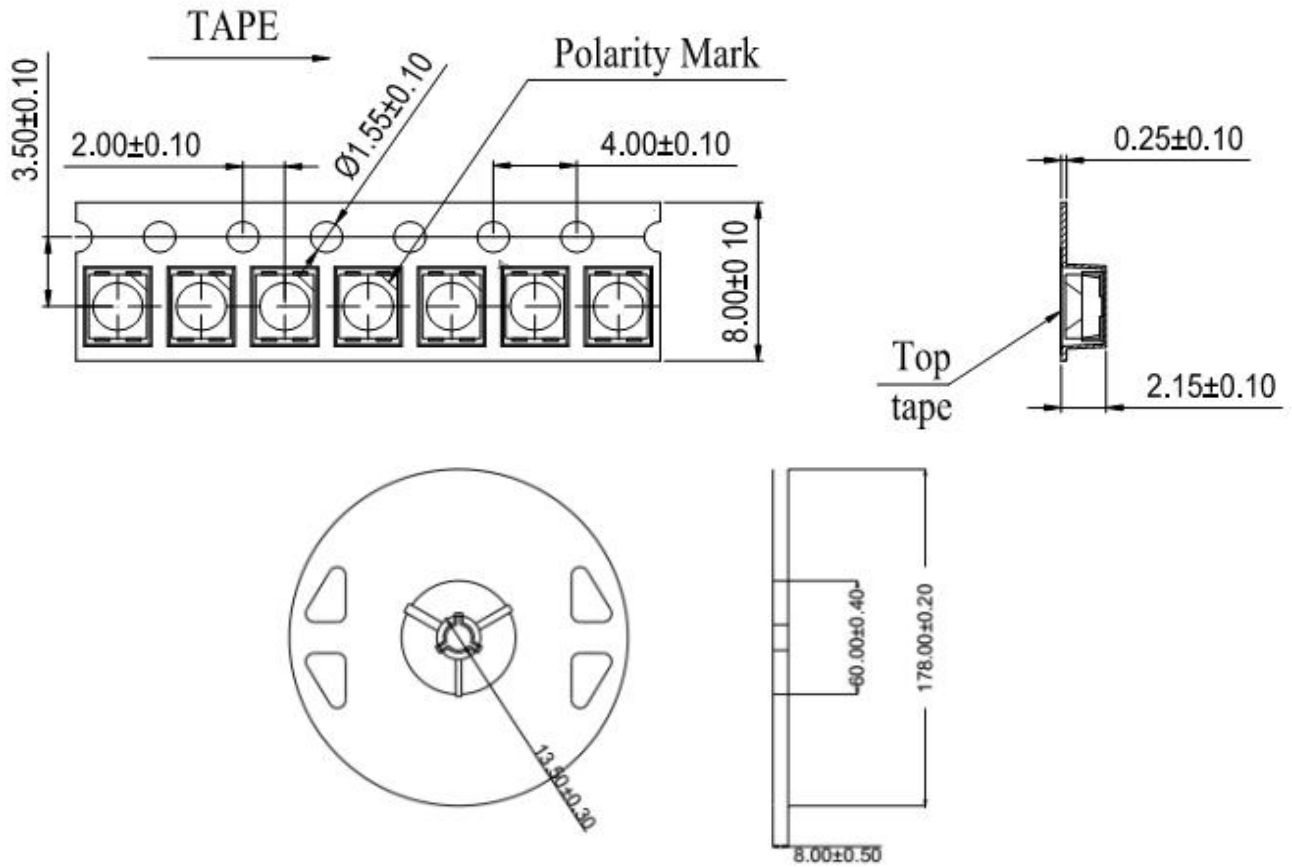

Carrier tape(MPQ:2000PCS/reel)

Note: The tolerances unless mentioned is ± 0.1 mm, Unit: mm

Moisture Resistant Packaging
