

Surface Mounted Chip LED
Model No. : CL-SP155UHRDLG
■ Features:

- Compatible with automatic placement equipment
- Compatible with reflow solder process

■ Applications:

- Automotive Telecommunication
- Indicators
- LCD Back-lights
- Illuminations

■ Absolute Maximum Ratings
(Ta=25°C)

Item	Symbol	Maximum	Unit
Peak Forward Current (1/10 Duty Cycle 0.1ms Pulse Width)	I _{FP}	100	mA
Reverse Voltage	V _R	5	V
Derating Linear From 25°C		0.4	mA/°C
Operating Temperature Range	T _{opr}	-40 to +85	°C
Storage Temperature Range	T _{stg}	-40 to +85	°C

■ Electrical / Optical Characteristics
(Ta=25°C)

Chip			Lens Appearance	Absolute Maximum Rating			Electro-optical Data (At 20mA)				Viewing Angle 2θ 1/2 (deg)
Emitted Color	λ _P (nm)	λ _D (nm)		Δλ (nm)	P _d (mW)	I _f (mA)	V _f (V)		I _v (mcd)		
	Typ.	Max.					Min.	Typ.			
Ultra High Red	645	631	Water Clear	15	78	30	2.1	2.6	90	108	130°
Green	523	525		30	100	30	3.1	3.5	550	650	

ISSUE	DIMENSION NO :	VERSION :	DATE :
		B	2022/02/10
	APPROVAL :	CHECK :	EDIT :

■ Packing coding principle

Bin code: K2-1-P2-1

Bin code	Stands For
K2	Luminous Intensity Grade
1	Dominant Wavelength Grade
P2	Luminous Intensity Grade
1	Dominant Wavelength Grade

■ The Luminous Intensity Grade of Ultra High Red Chip-LED Products

Test Condition: $I_f=20\text{mA}, T_a=25^\circ\text{C}$

Range, mcd	Bin code
72/90	K1
90/115	K2

* Luminous Intensity Tolerance: $\pm 10\%$

■ Dominant Wavelength Grade of Ultra High Red Chip-LED Products

Test Condition: $I_f=20\text{mA}, T_a=25^\circ\text{C}$

BIN	Range
1	623/627
2	627/640

* Dominant Wavelength Tolerance: $\pm 1\text{nm}$

■ The Luminous Intensity Grade of Green Chip-LED Products

● Test Condition: @ 20 mA

Range, mcd	Bin code
550/650	P2
650/750	Q1

* Luminous Intensity Tolerance: $\pm 10\%$

■ Dominant Wavelength Grade of Green Chip-LED Products

● type @ 20mA

BIN	Range
3	516.5~519
4	519~521.5
5	521.5~524

* Dominant Wavelength Tolerance: $\pm 1\text{nm}$

■ Reliability Test Items And Conditions

NO.	Item	Test Conditions	Test Hours / Cycle	Sample Q'ty	Ac / Re
1	Solder Heat	TEMP: 260°C ± 5°C	5 sec	36 pcs	0 / 1
2	Temperature Cycle	H: +100°C 30min. ∫ 5min. L: -40°C 30min.	50 cycle	36 pcs	0 / 1
3	Thermal Shock	H: +100°C 15min. ∫ 10sec L: -40°C 15min.	100 cycle	36 pcs	0 / 1
4	High Temperature Storage	TEMP: 100°C	1000 hrs	36 pcs	0 / 1
5	Low Temperature Storage	TEMP: -40°C	1000 hrs	36 pcs	0 / 1
6	DC Operating Life	I _F =20mA	1000 hrs	36 pcs	0 / 1
7	High Temperature / High Humidity	85°C / 90~95%R.H.	1000 hrs	36 pcs	0 / 1

■ Reflow Temp. / Time

Please refer to the following figure:

Temp.(°C)		Time(Sec)	
a	25	T0~T1	Max. 3°C/sec
b	150	T1~T2	90~130 sec
c	200	T2~T4	Max. 3°C/sec
d	220	T3~T6	Max. 50sec
e	245		
f	Max. 260		Max. 10sec
		T5~T7	Max. -3°C/sec
Blet Speed		70~90 cm/min	

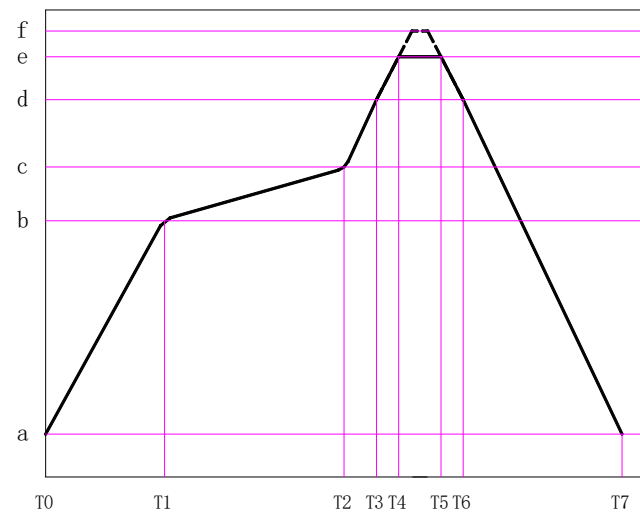

Soldering Iron:

Temperature at tip of iron: 300°C Max. (25W Max.)

Soldering time: 5 ± 1sec.

■ Precautions For Use

◆ Circuit design

1. Customer must apply resistors for protection and stable, Circuit B is recommended, If using Circuit A, the current through the LEDs may vary due to the variation in Forward Voltage characteristics of the LEDs(burn out will happen).

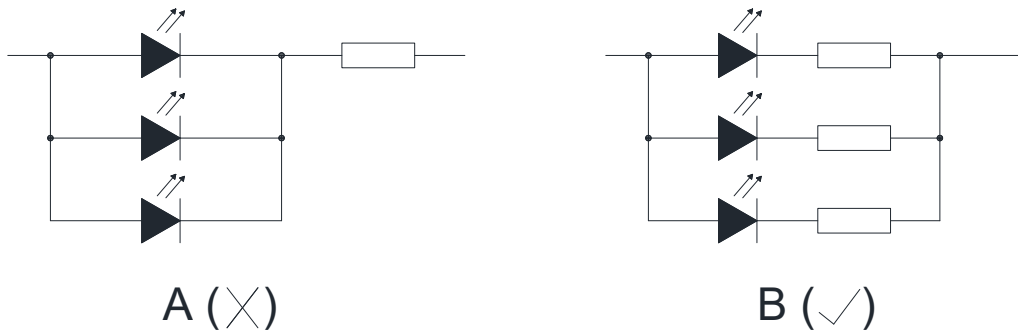

2. Current change may lead to LED color change. If there is a big difference among spectral color separation current and actual service current, color difference may happen.
3. This product should be operated using forward current. Subjecting it to continuous reverse voltage may cause migration, which may cause damage to the LED die.

◆ Handling Precautions

1. When handling the product with tweezers, be careful not to apply excessive force to the resin. Otherwise, the resin can be cut, chipped, delaminate or deformed, causing wire-bond breaks.

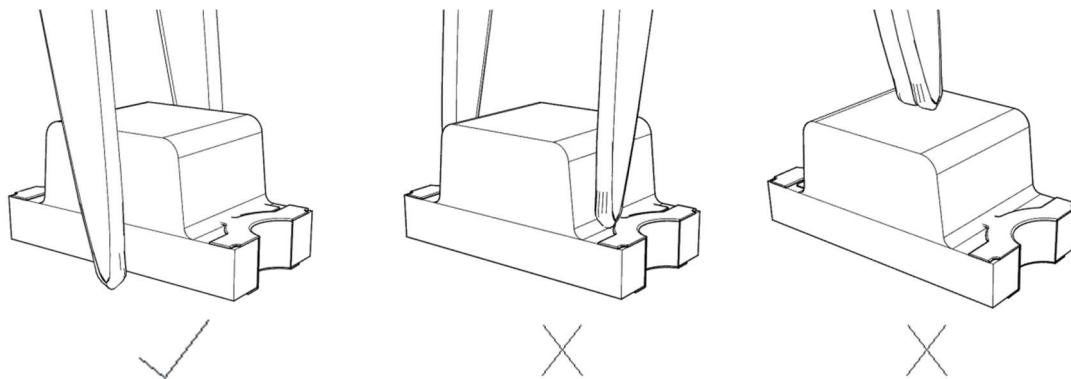

2. Reflow soldering must not be performed more than twice. Hand soldering must not be performed more than once.
3. When soldering, do not put stress on the LEDs during heating.
4. The product are sensitive to static electricity or surge voltage. ESD can damage a die and its reliability.
5. Do not stack assembled PCBs together. Failure to comply can cause the resin portion of the product to be cut, chipped, delaminated and/or deformed. It may leading to catastrophic failures.

■ Storage

1. The operation of temperature and R.H. are: $5^{\circ}\text{C} \sim 30^{\circ}\text{C}$, R.H.60% Max..
2. Once the package is opened, the products should be used within 24 hrs. Otherwise, they should be kept in a dampproof box with desiccating regent. Considering the tape life, we suggest our customers to use our products within 1 year (from production date) .
3. It's recommended to bake before soldering when the package is unsealed after 24 hrs. The condition is : $70^{\circ}\text{C} \pm 5^{\circ}\text{C}$ for 24hrs.

■ Package Dimensions

◆ Package Dimensions of Device (CL-SP155 Series)

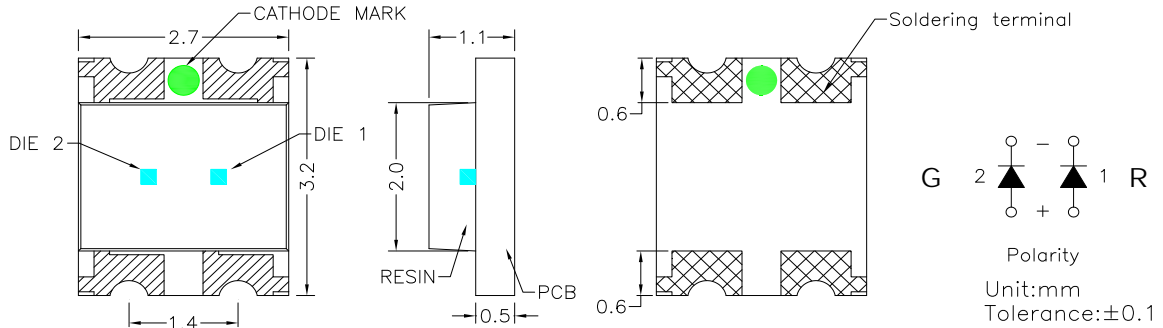

1. Soldering terminal may shift in x, y direction.
2. Polarity referring onto the cathode mark is reversed on the URUR/HRHR/SRSR

◆ Recommended Soldering Pad Dimensions

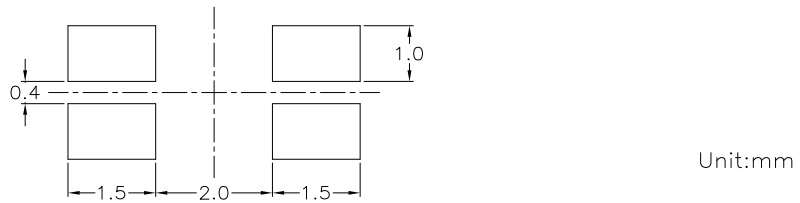

◆ Tape Specification : 3000pcs Per Reel

Packing Size													
Item	W	P1	E	F	Do	D1	Po	10Po	P2	Ao	Bo	Ko	t
Spec.	8.00	4.00	1.75	3.50	1.50	1.00	4.00	40.00	2.00	2.80	3.35	1.35	0.22
Tolerance	±0.20	±0.10	±0.10	±0.05	+0.10 -0.00	±0.05	±0.05	±0.20	±0.05	±0.10	±0.10	±0.10	±0.05

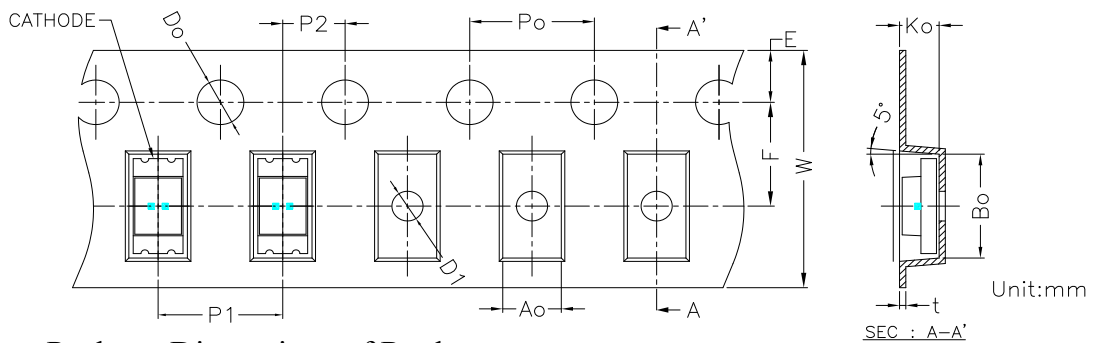

◆ Package Dimensions of Reel :

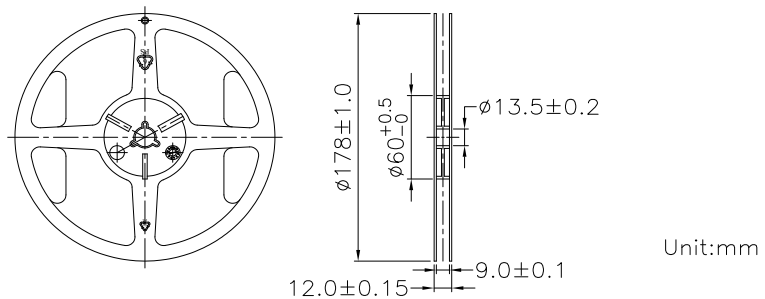

■ Typical optical characteristics curves

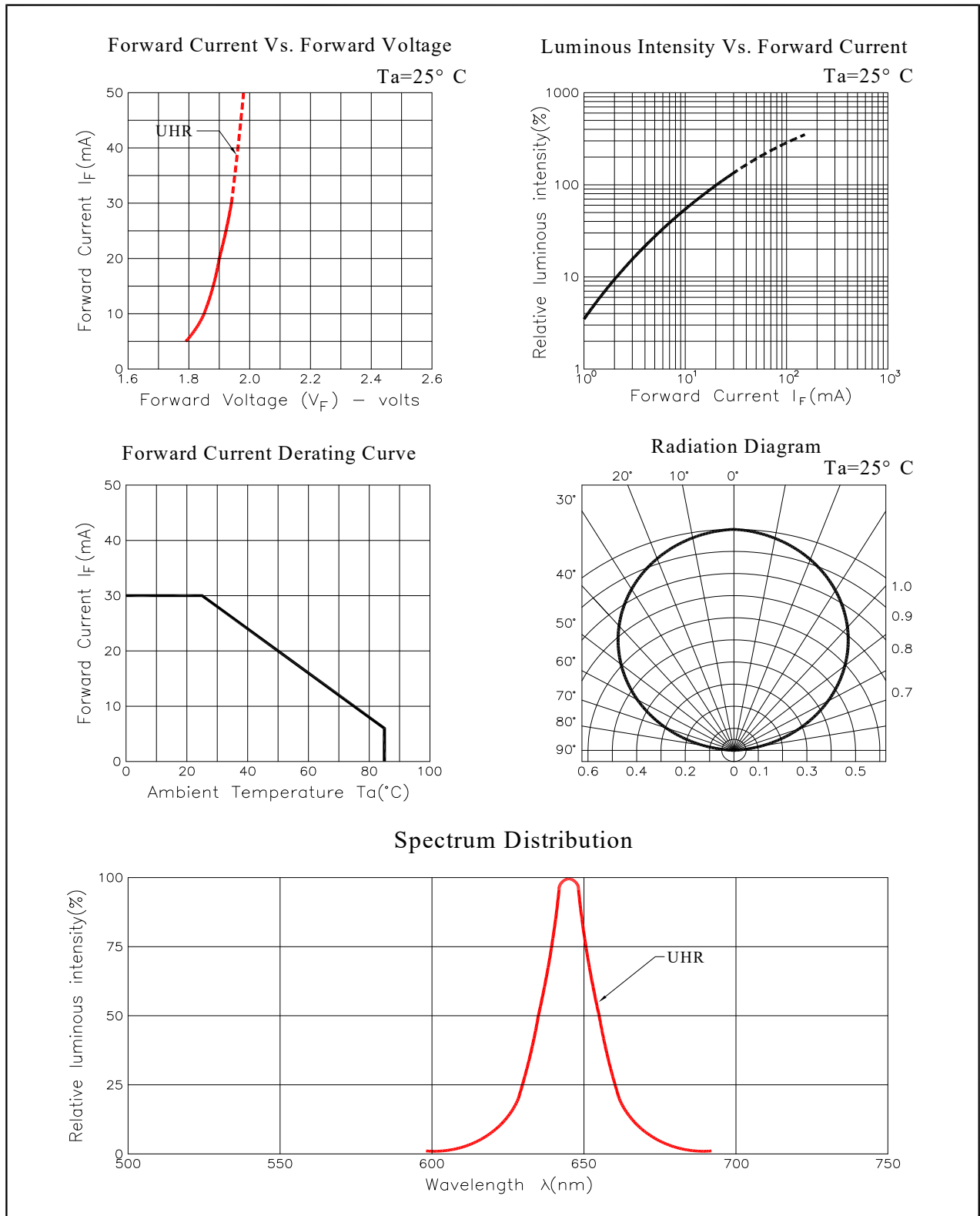

Forward Current Vs. Forward Voltage

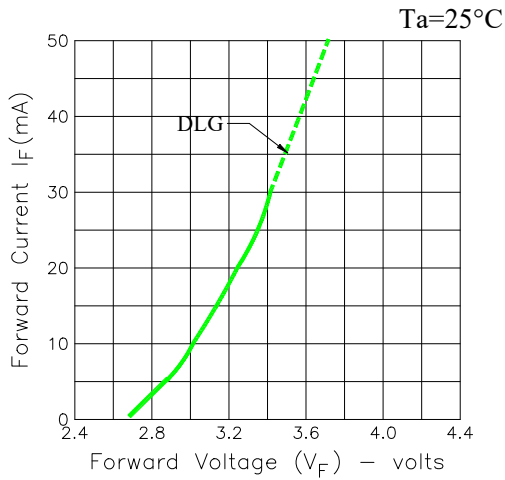

Luminous Intensity Vs. Forward Current

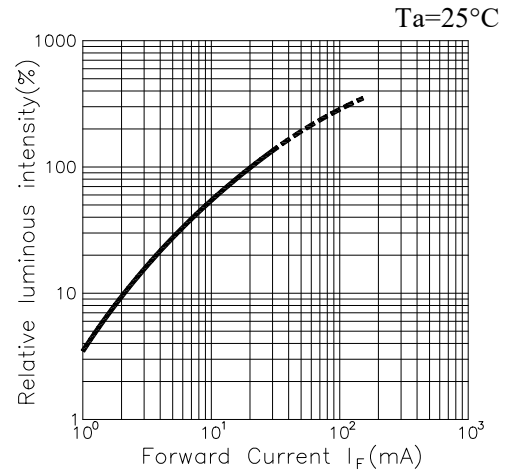

Forward Current Derating Curve

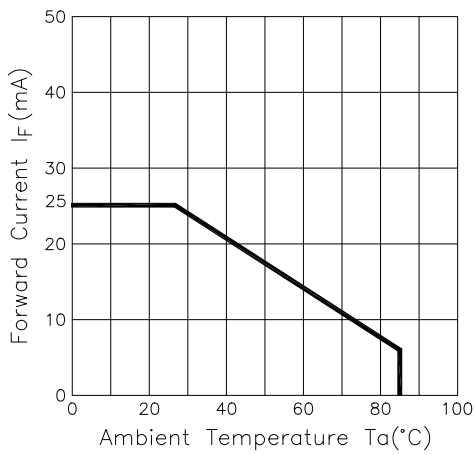

Radiation Diagram

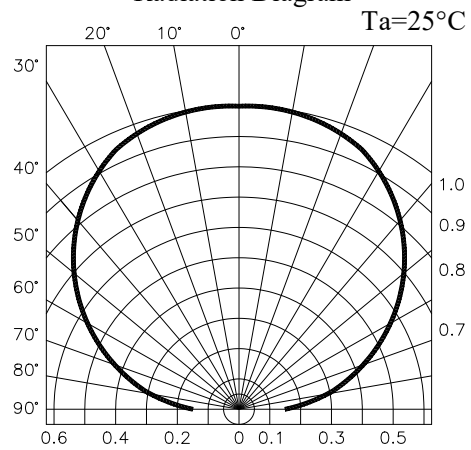

Spectrum Distribution

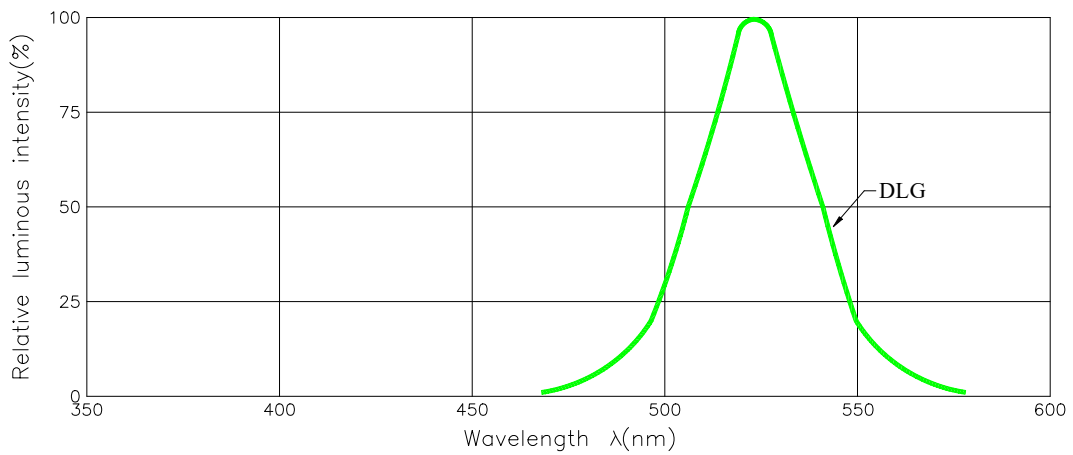

■ Moisture Resistant Packing Process

