



## Data Sheet

---

Customer: \_\_\_\_\_  
Part No: CL-SP110UYG  
Sample No: \_\_\_\_\_  
Description: 3210 SMD YellowGreen Color  
Item No: \_\_\_\_\_

Customer			
Check	Inspection	Approval	Date

**■ Features:**

- Compatible with automatic placement equipment
- Compatible with reflow solder process

**■ Applications:**

- Automotive Telecommunication
- Indicators
- LCD Back-lights
- Illuminations

Dice Material	Light Color	Lens Color
AlGaInP	Ultra Yellow Green	Water Clear

**■ Absolute Maximum Ratings**
**(Ta=25°C)**

Item	Symbol	Maximum	Unit
Power Dissipation	PD	78	mW
Continuous Forward Current	IF	30	mA
Peak Forward Current (1/10 Duty Cycle 0.1ms Pulse Width)	IFP	100	mA
Reverse Voltage	VR	5	V
Operating Temperature Range	Topr	-40 to +85	°C
Storage Temperature Range	Tstg	-40 to +85	°C

**■ Electrical / Optical Characteristics**
**(Ta=25°C)**

Item	Symbol	Condition	Min.	Typ.	Max.	Unit
Forward Voltage	V <sub>F</sub>	IF=20mA	1.8	2	2.3	V
Reverse Current	IR	VR=5V			10	uA
Peak Emission Wavelength	λ <sub>P</sub>	IF=20mA		575		nm
Dominant Wavelength	λ <sub>D</sub>	IF=20mA		572		nm
Viewing Angle	2θ <sub>1/2</sub>	IF=20mA		110		Deg
Luminous Intensity	I <sub>v</sub>	IF=20mA	18	45	115	mcd

ISSUE	DIMENSION NO :	VERSION :	DATE :
	APPROVAL :	CHECK :	EDIT :

**■ Packing coding principle**

Bin code (e.g): G-0-4

Bin code	Stands For
G	Luminous Intensity Grade
0	Dominant Wavelength Grade
4	Forward Voltage Grade

**■ The Luminous Intensity Grade of Ultra Yellow Green Chip-LED Products**

Test Condition:  $I_f=20\text{mA}$ ,  $T_a=25^\circ\text{C}$

Bin code	Range,mcd	Bin code	Range,mcd	Bin code	Range,mcd
G	18/28.5	H	28.5/45	J	45/72
K	72/115				

\* Luminous Intensity Tolerance:  $\pm 10\%$

**■ Dominant Wavelength Grade of Ultra Yellow Green Chip-LED Products**

Test Condition:  $I_f=20\text{mA}$ ,  $T_a=25^\circ\text{C}$

Bin code	Range, nm	Bin code	Range, nm	Bin code	Range, nm
0	568/570	1	570/572	2	572/574
3	574/576	4	576/578		

\* Dominant Wavelength Tolerance:  $\pm 1\text{nm}$

**■ Forward Voltage Grade of Ultra Yellow Green Chip-LED Products**

Test Condition:  $I_f=20\text{mA}$ ,  $T_a=25^\circ\text{C}$

Bin code	Range,V	Bin code	Range,V	Bin code	Range,V
4	1.8/1.9	5	1.9/2.0	6	2.0/2.1
7	2.1/2.2	8	2.2/2.3		

\* Forward Voltage Tolerance:  $\pm 0.1\text{V}$

**■ Reliability Test Items And Conditions**

NO.	Item	Test Conditions	Test Hours / Cycle	Sample Q'ty	Ac / Re
1	Solder Heat	TEMP: 260°C ± 5°C	5 sec	36 pcs	0 / 1
2	Temperature Cycle	H: +100°C 30min. ∫ 5min. L: -40°C 30min.	50 cycle	36 pcs	0 / 1
3	Thermal Shock	H: +100°C 15min. ∫ 10sec L: -40°C 15min.	100 cycle	36 pcs	0 / 1
4	High Temperature Storage	TEMP: 100°C	1000 hrs	36 pcs	0 / 1
5	Low Temperature Storage	TEMP: -40°C	1000 hrs	36 pcs	0 / 1
6	DC Operating Life	I <sub>F</sub> = 20mA	1000 hrs	36 pcs	0 / 1
7	High Temperature / High Humidity	85°C / 90~95%R.H.	1000 hrs	36 pcs	0 / 1

**■ Reflow Temp. / Time**

Please refer to the following figure:

Temp. (°C)	Time (Sec)	
a 25	T0~T1	Max. 3°C/sec
b 150	T1~T2	90~130 sec
c 200	T2~T4	Max. 3°C/sec
d 220	T3~T6	Max. 50sec
e 245		
f Max. 260		Max. 10sec
	T5~T7	Max. -3°C/sec
Blet Speed	70~90 cm/min	

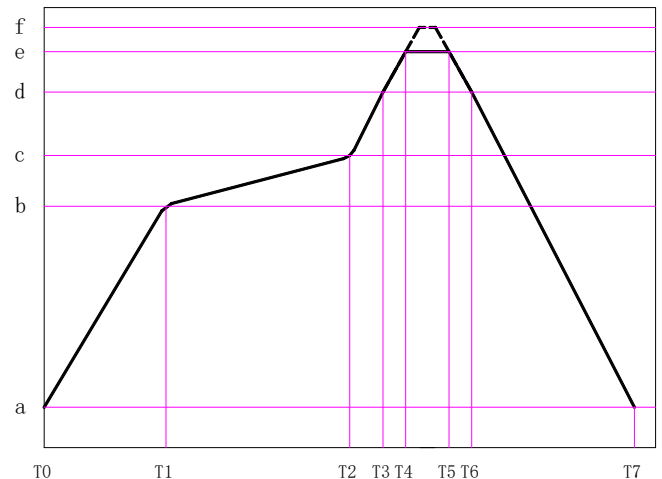
**■ Soldering Iron**

Temperature at tip of iron: 300°C Max. (25W Max.)

Soldering time: 5 ± 1sec.

## ■ Precautions For Use

### ◆ Circuit design

1. Customer must apply resistors for protection and stable, Circuit B is recommended, If using Circuit A, the current through the LEDs may vary due to the variation in Forward Voltage characteristics of the LEDs(burn out will happen).

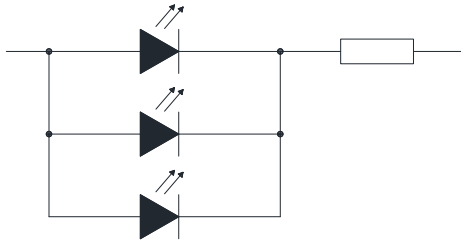

A (X)

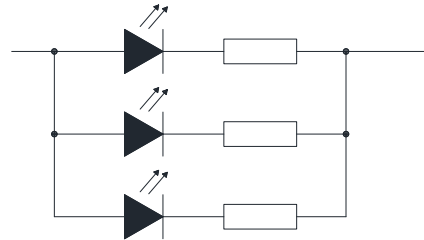

B (✓)

2. Current change may lead to LED color change. If there is a big difference among spectral color separation current and actual service current, color difference may happen.
3. This product should be operated using forward current. Subjecting it to continuous reverse voltage may cause migration, which may cause damage to the LED die.

### ◆ Handling Precautions

1. When handling the product with tweezers, be careful not to apply excessive force to the resin. Otherwise, the resin can be cut, chipped, delaminate or deformed, causing wire-bond breaks.

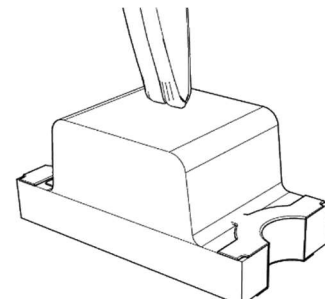
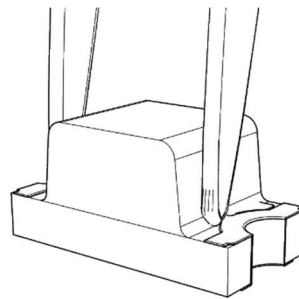
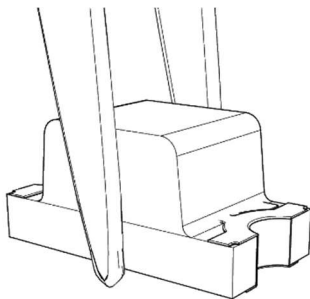

2. Reflow soldering must not be performed more than twice. Hand soldering must not be performed more than once.
3. When soldering, do not put stress on the LEDs during heating.
4. The product are sensitive to static electricity or surge voltage. ESD can damage a die and its reliability.
5. Do not stack assembled PCBs together. Failure to comply can cause the resin portion of the product to be cut, chipped, delaminated and/or deformed. It may leading to catastrophic failures.

## ■ Storage

1. The operation of temperature and R.H. are:  $5^{\circ}\text{C} \sim 30^{\circ}\text{C}$ , R.H.60% Max..
2. The LEDs should be used within a year ( from production date ) .
3. Once the package is opened, the products should be used within 72 hrs. Otherwise, they should be kept in a dampproof box with desiccating regent.
4. It's recommended to bake before soldering when the package is unsealed after 72 hrs. The condition is :  $70^{\circ}\text{C} \pm 5^{\circ}\text{C}$  for 24hrs.

## ■ Package Dimensions

### ◆ Package Dimensions of Device ( CL-SP110 Series )

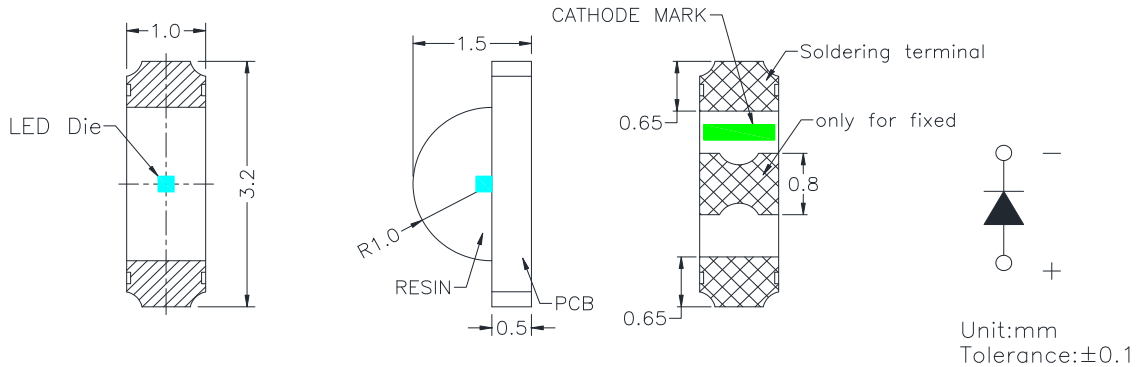

1. Soldering terminal may shift in x, y direction.
2. Polarity referring onto the cathode mark is reversed on the UR/HR/SR

### ◆ Recommended Soldering Pad Dimensions

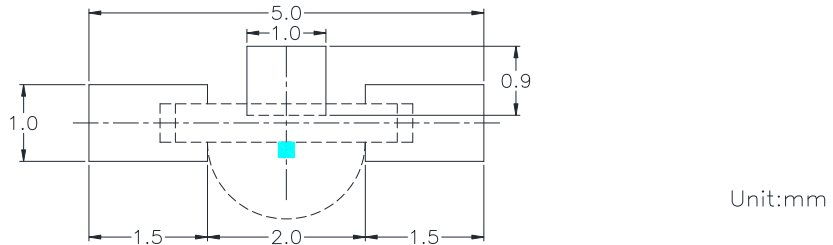

### ◆ Tape Specification : 3000pcs Per Reel

Packing Size													
Item	W	P1	E	F	Do	D1	Po	10Po	P2	Ao	Bo	Ko	t
Spec.	8.00	4.00	1.75	3.50	1.50	1.00	4.00	40.00	2.00	1.60	3.35	1.15	0.22
Tolerance	±0.20	±0.10	±0.10	±0.05	$\begin{smallmatrix} +0.10 \\ -0.00 \end{smallmatrix}$	±0.05	±0.05	±0.20	±0.05	±0.10	±0.10	±0.10	±0.05

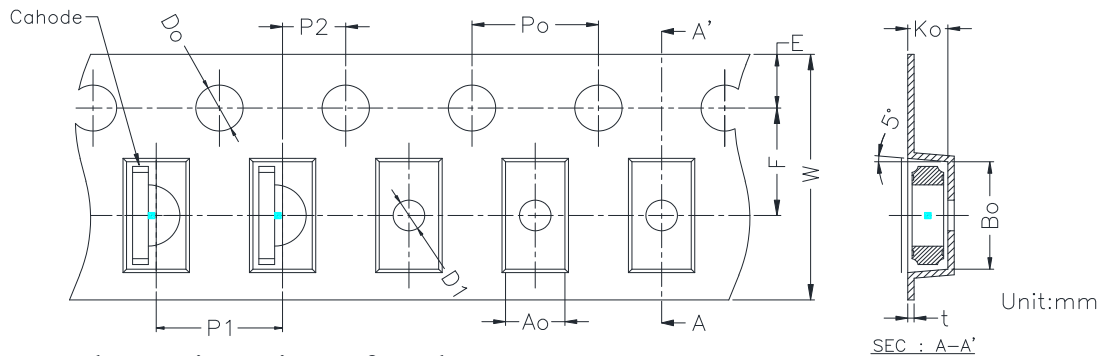

### ◆ Package Dimensions of Reel :

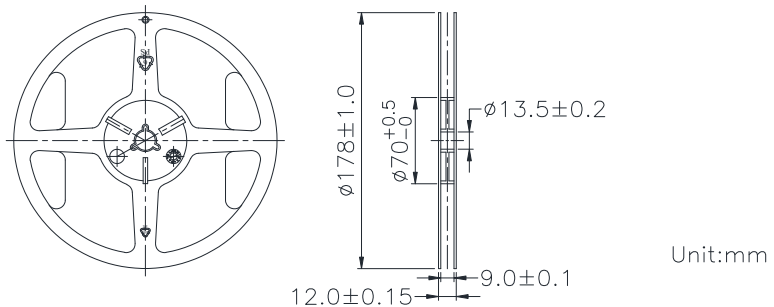

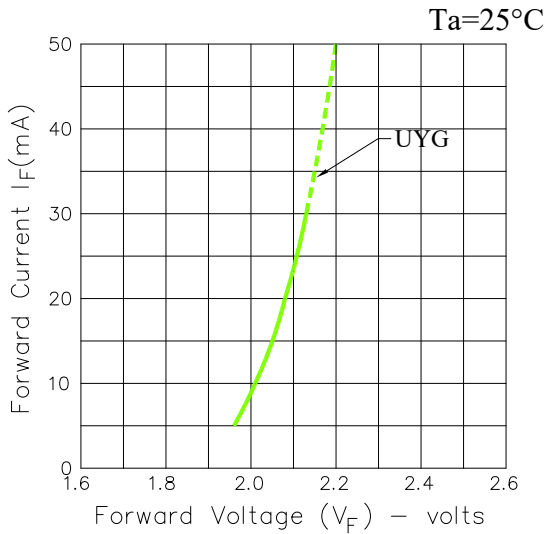
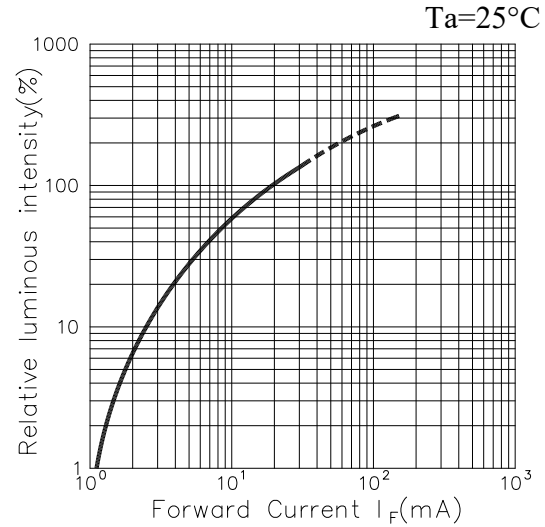
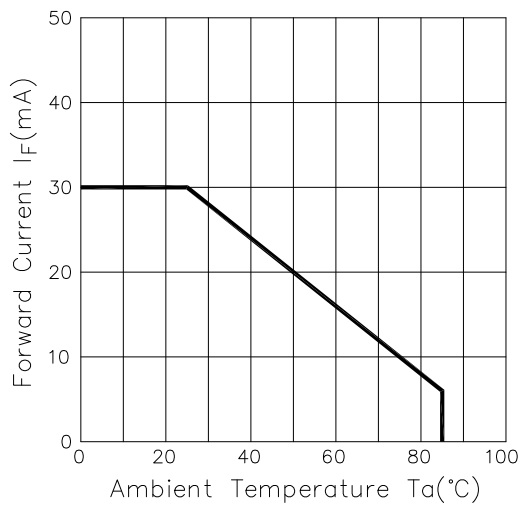
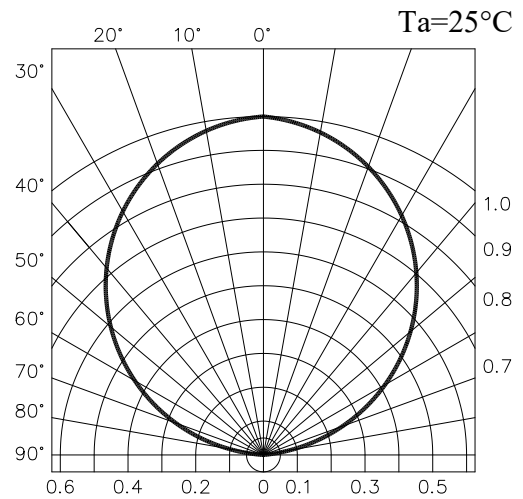
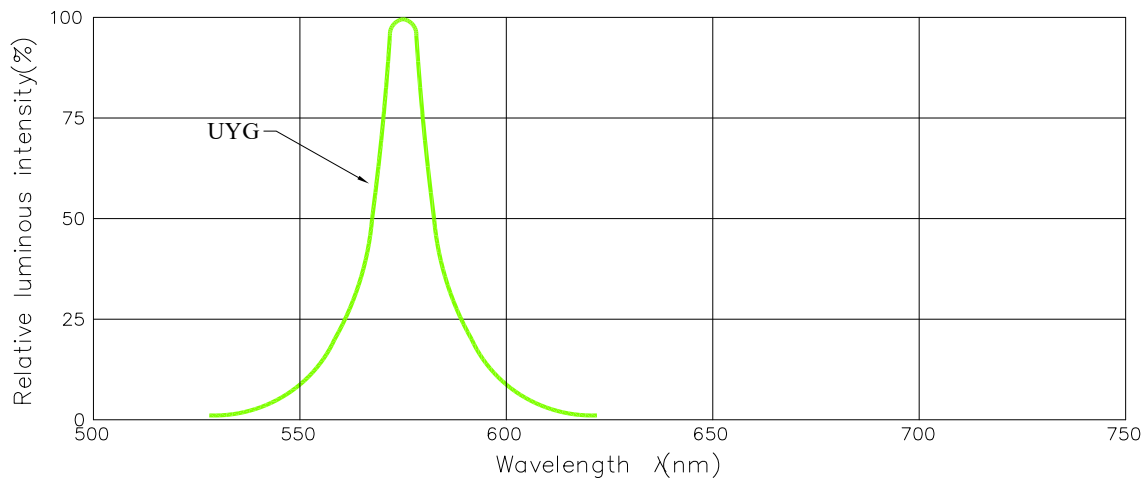
**Typical optical characteristics curves**
**Forward Current Vs. Forward Voltage**

**Luminous Intensity Vs. Forward Current**

**Forward Current Derating Curve**

**Radiation Diagram**

**Spectrum Distribution**



■ Outer Packing Dimensions

