

CL- 3014UYC1A- 010

Features:

- High intensity
- General purpose leads
- RoHS compliant.

Descriptions:

- Dice material: AlGaInP
- Emitting Color: Super bright Yellow
- Device Outline: $\Phi 3\text{mm}$ Round Type.
- Lens Type: water clear.

Radiation pattern.

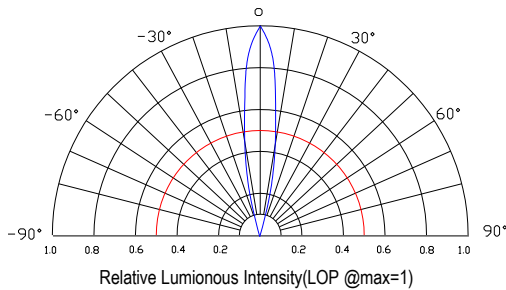

Package configuration

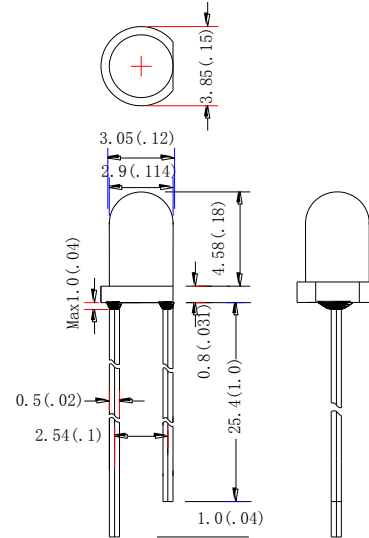

- ◆ All dimensions are millimeters (inches)
- ◆ Tolerance is $\pm 0.25\text{mm}(0.010\text{'})$ unless otherwise noted.

Absolute maximum ratings($T_a=25\text{ }^\circ\text{C}$)

Parameter	MAX.	Unit
Power Dissipation	50	mW
Peak Forward Current (1/10 Duty Cycle, 0.1ms Pulse Width)	100	mA
Continuous Forward Current	20	mA
Derating Linear From $50\text{ }^\circ\text{C}$	0.4	mA/ $^\circ\text{C}$
Reverse Voltage	5	V
Operating Temperature Range	$-30\text{ }^\circ\text{C}$ to $+80\text{ }^\circ\text{C}$	
Storage Temperature Range	$-40\text{ }^\circ\text{C}$ to $+100\text{ }^\circ\text{C}$	
Lead Soldering Temperature[4mm(.157") From Body]	260 $^\circ\text{C}$ for 5 Seconds	

Electrical and optical characteristics($T_a=25\text{ }^\circ\text{C}$)

Parameter	Symbol	Min.	Typ.	Max.	Unit	Test Condition
Luminous Intensity	I_v	-	800	-	mcd	$I_F=20\text{mA}$
Viewing Angle	$2\theta_{1/2}$	13	18	23	Deg	
Peak Emission	λ_p		588		nm	
Dominant Wavelength	λ_d	585	590	595	nm	
Spectral Line Half-Width	$\Delta\lambda$	10	15	20	nm	
Forward Voltage	V_F	1.9	2.2	2.4	V	$V_R=5\text{V}$
Reverse Current	I_R			10	μA	

Typical Electrical Characteristics Curves (25 °c Ambient Temperature Unless Otherwise Noted)

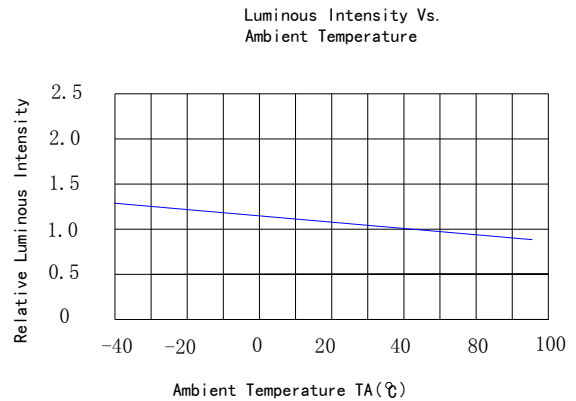
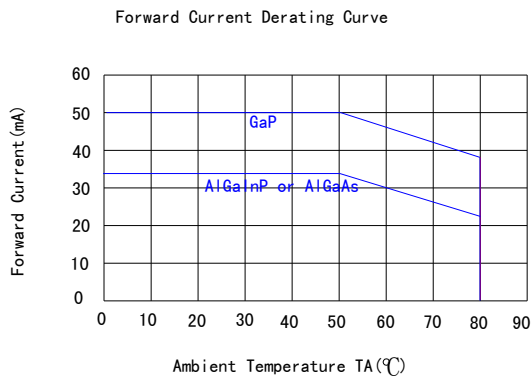
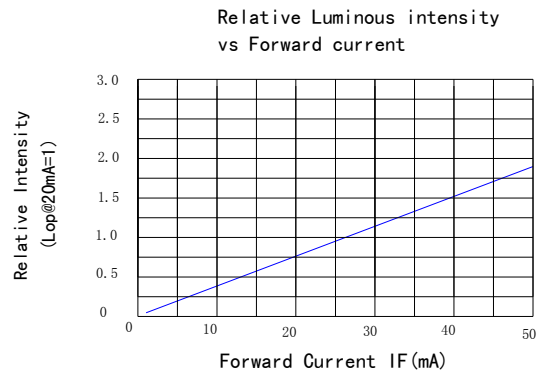
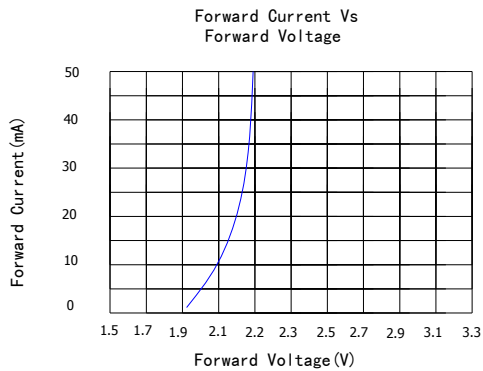
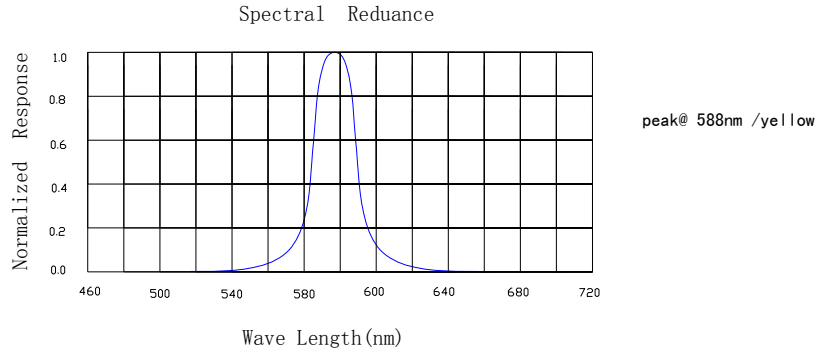

LAMP PACKING.

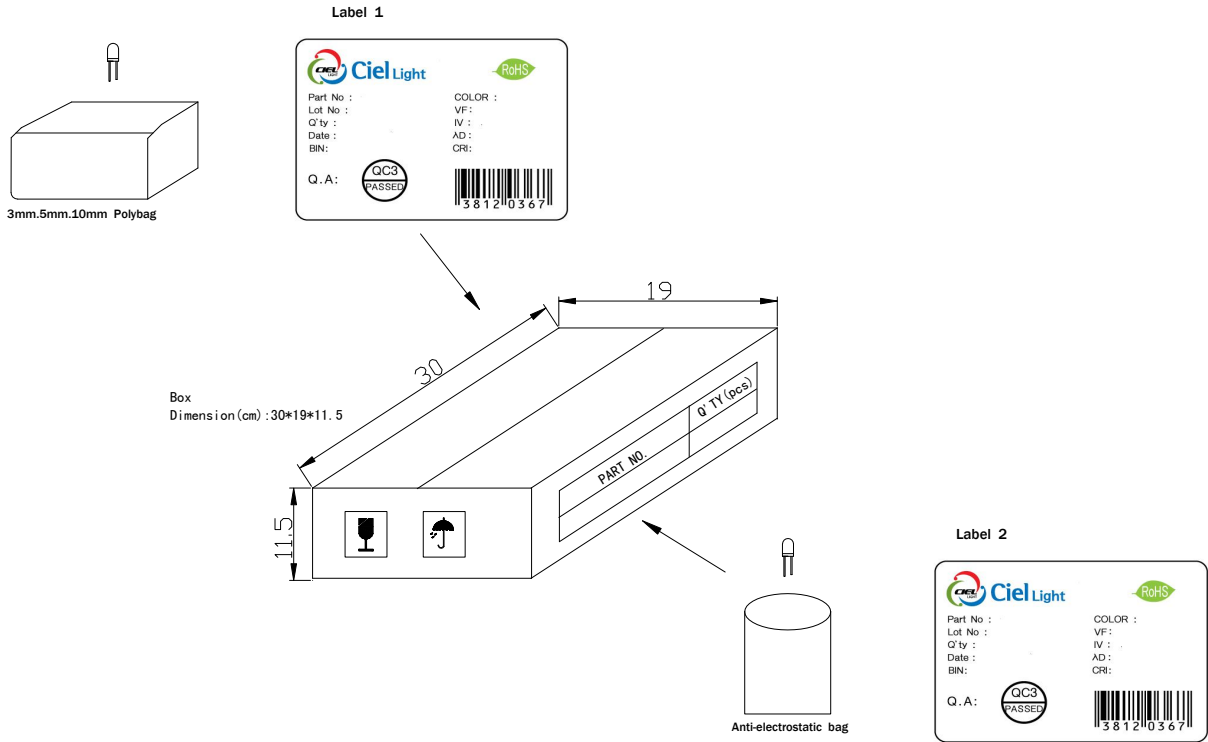

DEVICE	QTY/polybag(pcs)	Polybag/box A	Fig
5mm(T-1 3/4)	1000	8 bags	Label 1
3mm(T-1)	1000	10 bags	Label 1
10mm(T-1)	250	8 bags	Label 1
Blue/Green/White	500	8 bags	Label 2

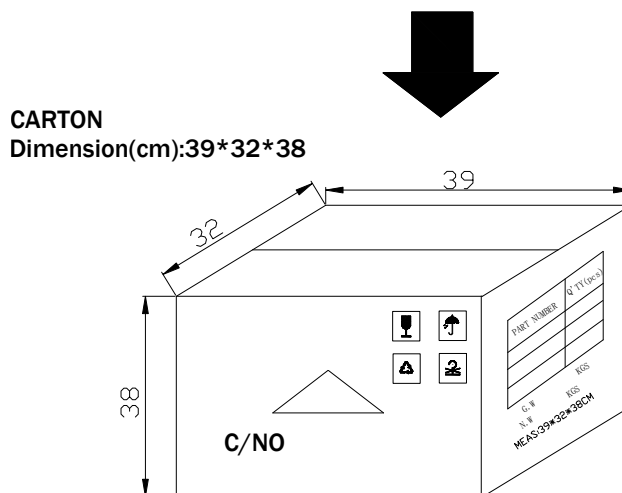

6 Boxes/Carton
 5mm:48,000pcs
 3mm:60,000pcs
 10mm:12,000pcs
 Blue/Pure Green/bluish Green
 /White:24,000pcs